

F4 MultiTrack Field Recorder

Operation Manual

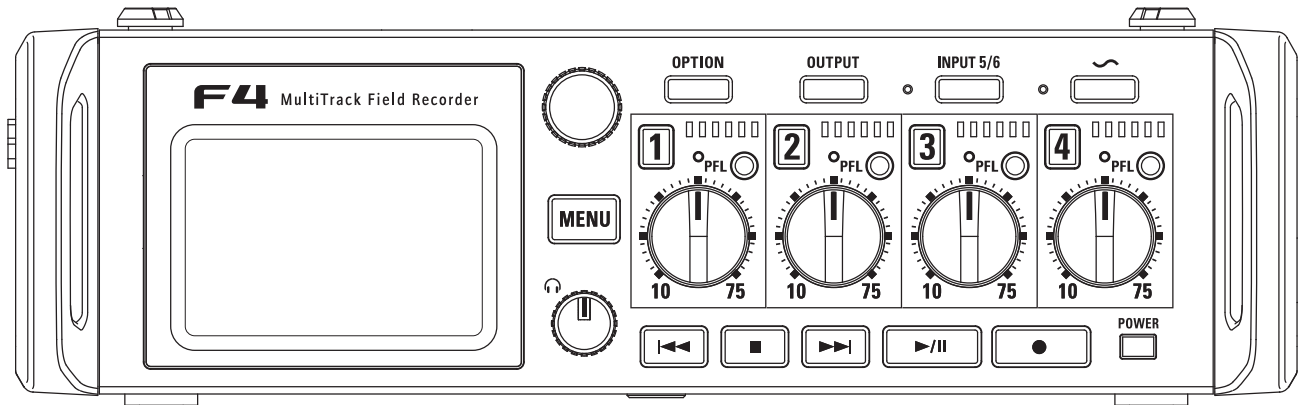

Usage and Safety Precautions

Safety Precautions

In this operation manual, symbols are used to highlight warnings and cautions that you must read to prevent accidents. The meanings of these symbols are as follows.



Something that could cause serious injury or death



Something that could cause injury or damage to the equipment

Other symbols used



An action that is mandatory



An action that is prohibited

Warning

Operation with an AC adapter

- ❗ Never use any AC adapter other than a ZOOM AD-19.

Operation with an external DC power supply

- ❗ Use a 9V–16V external DC power supply.
- ❗ Carefully study the warning indications of the external DC power supply before use.

Operation with batteries

- ❗ Use 8 commercially-available 1.5V AA batteries (alkaline dry cell batteries, nickel metal hydride batteries or lithium dry cell batteries).
- ❗ Carefully study the warning indications of the batteries before use.
- ❗ Always keep the battery cover closed during use.

Alterations

- ⊘ Do not open the case or modify the product.

Caution

Product handling

- ❗ Do not drop, bump or apply excessive force to the unit.
- ❗ Be careful not to allow foreign objects or liquids to enter the unit.

Operating environment

- ⊘ Do not use in extremely high or low temperatures.
- ⊘ Do not use near heaters, stoves and other heat sources.
- ⊘ Do not use in very high humidity or where it could be splashed by water.
- ⊘ Do not use in places with frequent vibrations.
- ⊘ Do not use in places with much dust or sand.

AC adapter handling

- ❗ When disconnecting the power plug from an outlet, always pull on the plug itself.
- ❗ Disconnect the power plug from the outlet when the unit will not be used for a long time and whenever there is lightning.

Battery handling

- ❗ Install batteries with the correct +/- orientations.
- ❗ Use the specified batteries. Do not use new and old batteries together. Do not use batteries of different brands or types together.
- ❗ Remove the batteries when the unit will not be used for a long time. If a leak occurs, thoroughly wipe the battery case and battery terminals to remove the leaked fluid.

Mic handling

- ❗ Always turn the power switch OFF before connecting a mic. Do not apply unnecessary force when connecting a mic.
- ❗ Attach the protective cap when no mic is connected for a long time.

Connection cables and input/output jacks

- ❗ Always turn the power OFF for all equipment before connecting any cables.
- ❗ Always disconnect all connection cables and the AC adapter before moving the unit.

Volume

- ⊘ Do not use at a loud volume for a long time.

Usage Precautions

Interference with other electrical equipment

In consideration of safety, the **F4** has been designed to minimize its emission of electromagnetic waves and to suppress interference from external electromagnetic waves. However, equipment that is very susceptible to interference or that emits powerful electromagnetic waves could result in interference if placed nearby. If this occurs, place the **F4** and the other device farther apart.

With any type of electronic device that uses digital control, including the **F4**, electromagnetic interference could cause malfunction, corrupt or destroy data and result in other unexpected trouble. Always use caution.

Cleaning

Use a soft cloth to clean the exterior of the unit if it becomes dirty. If necessary, use a damp cloth that has been wrung out well to wipe it. Never use abrasive cleansers, wax or solvents such as alcohol, benzene or paint thinner.

Breakdown and malfunction

If the unit becomes broken or malfunctions, immediately turn the power off, disconnect the external power supply, remove the batteries and disconnect other cables. Contact the store where you bought the unit or ZOOM service with the following information: product model, serial number and specific symptoms of breakdown or malfunction, along with your name, address and telephone number.

Copyrights

© Windows®, Windows® 8 and Windows® 7 are trademarks or registered trademarks of Microsoft® Corporation.

© Macintosh and Mac OS are trademarks or registered trademarks of Apple Inc.

© The SD, SDHC and SDXC logos are trademarks. MPEG Layer-3 audio compression technology is licensed from Fraunhofer IIS and Sisvel S.p.A.

© Other product names, registered trademarks and company names in this document are the property of their respective companies.

Note: All trademarks and registered trademarks in this document are for identification purposes only and are not intended to infringe on the copyrights of their respective owners.

Recording from copyrighted sources, including CDs, records, tapes, live performances, video works and broadcasts, without permission of the copyright holder for any purpose other than personal use is prohibited by law. Zoom Corporation will not assume any responsibility related to infringements of copyrights.

Note about the Auto Power Off function

The power will automatically turn off if unused for 10 hours. If you want the power to stay on always, see “Disabling the Auto Power Off function” on P.17 and turn the function OFF.

FCC regulation warning (for U.S.A.)

NOTE: This equipment has been tested and found to comply with the limits for a Class B digital device, pursuant to Part 15 of the FCC Rules. These limits are designed to provide reasonable protection against harmful interference in a residential installation. This equipment generates, uses and can radiate radio frequency energy and, if not installed and used in accordance with the instructions, may cause harmful interference to radio communications. However, there is no guarantee that interference will not occur in a particular installation. If this equipment does cause harmful interference to radio or television reception, which can be determined by turning the equipment off and on, the user is encouraged to try to correct the interference by one or more of the following measures:

- Reorient or relocate the receiving antenna.
- Increase the separation between the equipment and receiver.
- Connect the equipment into an outlet on a circuit different from that to which the receiver is connected.
- Consult the dealer or an experienced radio/TV technician for help.

For EU Countries

Declaration of Conformity

Contents

| | |
|---|-----|
| Usage and Safety Precautions | 02 |
| Contents | 04 |
| Introduction | 05 |
| Names of parts | 06 |
| Connecting mics/other devices to Inputs 1-6 | 08 |
| LCD display | 11 |
| Preparations | |
| Supplying power | 14 |
| Loading SD cards | 16 |
| Turning the power on and off | 17 |
| Setting the date and time (Date/Time (RTC)) | 18 |
| Setting the power supply used (Power Source) | 20 |
| Recording | |
| Recording process | 22 |
| Setting the SD card used for recording and recording file format | 23 |
| Selecting inputs | 25 |
| Adjusting the input levels and monitoring balance | 27 |
| Recording | 29 |
| Setting the sampling rate (Sample Rate) | 30 |
| Setting WAV file bit depth (WAV Bit Depth) | 31 |
| Setting MP3 file bit depth (MP3 Bit Rate) | 32 |
| Recording two tracks at different levels (Dual Channel Rec.) | 33 |
| Capturing audio before recording starts (Pre Rec) | 35 |
| Setting the maximum file size (File Max Size) | 36 |
| Folder and file structure | 37 |
| Moving the previously recorded take to the FALSE TAKE folder | 39 |
| Recorded take settings | |
| Changing the note for the next take recorded (Note) | 40 |
| Setting how recorded scenes are named and numbered (Scene) | 42 |
| Setting the take reset condition and numbering format (Take) | 45 |
| Changing the track name of the next take recorded (Track Name) | 47 |
| Playback | |
| Playing recordings | 49 |
| Mixing takes | 50 |
| Changing the playback mode (Play Mode) | 51 |
| Take and folder operations | |
| Take and folder operations (Finder) | 52 |
| Overview of take metadata stored in files | 59 |
| Checking and editing take metadata (Metadata Edit) | 60 |
| Writing a sound report (Create Sound Report) | 67 |
| Input settings | |
| Input and output signal flow | 70 |
| Adjusting the L/R track volume | 71 |
| Monitoring the input signals of specified tracks (PFL/SOLO) | 72 |
| Setting the monitoring volume on the PFL screen (PFL Mode) | 73 |
| Cutting low-frequency noise (HPF) | 74 |
| Input limiter | 75 |
| Inverting the input phase (Phase Invert) | 79 |
| Changing the phantom power settings (Phantom) | 80 |
| Changing the plugin power setting (Plugin Power) | 83 |
| Applying delay to input signals (Input Delay) | 84 |
| Converting mid-side input to stereo (Stereo Link Mode) | 85 |
| Adjusting multiple track input levels together (Trim Link) | 87 |
| Using Input 5/6 as a return (RTN) input | 88 |
| Adjusting the side mic level of a mid-side mic capsule (Side Mic Level) | 89 |
| Output settings | |
| Setting signals sent to the output jacks (Routing) | 90 |
| Disabling outputs (Output On/Off) | 94 |
| Setting the standard output level (Output Level) | 95 |
| Setting the output level | 96 |
| Applying delay to the output (Output Delay) | 97 |
| Output Limiter | 98 |
| Outputting alerts through headphones (Alert Tone Level) | 102 |
| TIMECODE | |
| Timecode overview | 103 |
| Making timecode settings | 105 |
| Setting the frame rate for internal timecode (FPS) | 109 |
| Jamming internal timecode (Jam) | 110 |
| Restarting internal timecode with a specified value (Restart) | 111 |
| Setting the automatic timecode recording delay (Auto Rec Delay) | 112 |
| Setting the user bits for internal timecode (Ubits) | 113 |
| Setting how timecode is initialized at startup (Start Timecode) | 115 |
| Slate tones | |
| Using slate tones (Slate Tone) | 116 |
| Using USB functions | |
| Exchanging data with a computer (SD Card Reader) | 119 |
| Using as an audio interface (Audio Interface) | 120 |
| Audio interface block diagrams | 122 |
| Audio interface settings | 124 |
| Using an FRC-8 | |
| Using an FRC-8 as a controller (Connect) | 125 |
| Setting the FRC-8 connected keyboard type (Keyboard type) | 126 |
| Setting user keys for the FRC-8 (User Key) | 127 |
| Setting the power supply used by the FRC-8 (Power Source) | 128 |
| Powering the FRC-8 with USB bus power (USB Bus Power) | 129 |
| Setting the FRC-8 LED brightness (LED Brightness) | 130 |
| Updating the FRC-8 firmware | 131 |
| Various settings | |
| Setting the level meter display (Level Meter) | 133 |
| Making display settings (LCD) | 136 |
| Setting the LED brightness (LED Brightness) | 138 |
| Setting how marks are added manually (PLAY Key Option) | 139 |
| Other functions | |
| Checking SD card information (Information) | 141 |
| Testing SD card performance (Performance Test) | 142 |
| Formatting SD cards (Format) | 144 |
| Checking the F4 shortcut list (Shortcut List) | 145 |
| Restoring default setting values (Factory Reset) | 146 |
| Checking the firmware version (Firmware Version) | 147 |
| Updating the firmware | 148 |
| Appendix | |
| Troubleshooting | 149 |
| Detailed product diagrams | 150 |
| Metadata list | 152 |
| List of shortcuts | 156 |
| Specifications | 157 |

Introduction

Thank you very much for purchasing a ZOOM **F4** Multitrack Field Recorder. The **F4** has the following features.

- **4 analog input channels with super-high-quality preamps**

The two sets of lockable XLR/TRS combo jacks provide high-quality analog input with -127dBu or less EIN, $+75\text{dB}$ maximum input gain and support for $+4\text{dB}$ input.

- **PCM recording at up to 192kHz/24-bit resolution**

- **Record up to 8 tracks at once**

Inputs 1–6 and a stereo mix with left and right tracks can be recorded at the same time for a maximum of 8 total simultaneous recording tracks (even at 192kHz sampling rate).

- **Dual channel recording allows a second file to be recorded simultaneously at a lower level (inputs 1–2)**

By lowering the input level of dual channel recording, you can create backup recordings to use if unexpected loud noise should cause the regular recordings to distort, for example.

- **Limiters with a new design suppresses distortion**

10 dB of headroom prevents distortion even more than an ordinary limiter. A threshold can be set to keep the signal below that level.

- **Supports SMPTE timecode input and output**

The **F4** uses a high-precision oscillator that enables the generation of accurate timecode with a discrepancy of less than 0.5 frames per 24 hours.

- **Outputs include a powerful 100mW+100mW headphone jack and MAIN OUT 1/2 and SUB OUT 1/2 jacks**

MAIN OUT 1/2 are XLR connectors. These outputs allow you to send audio signals to a video camera and other devices while monitoring with headphones.

- **Support for return (RTN) input**

Monitor the output of a DSLR camera without recording it with the **F4**.

- **With flexible signal routing, mixer use is also possible**

Prefader and postfader signals from inputs 1–6 can be routed to outputs freely.

- **Phantom power (+24V/+48V) can be supplied**

This can be turned on/off for each input separately.

- **Two types of DC power supplies can be used**

Both AA batteries and 9–16V DC power supplies can be used.

- **Two SDXC card slots**

Simultaneous recording to 2 SD cards is possible. In addition, SDXC card support enables recording for even longer times than before. Moreover, it can be used as a card reader by connecting to a computer using USB.

- **Usable as a USB audio interface with up to 6 ins and 4 outs**

The **F4** can be used not only as a 2-in/2-out audio interface, but also as an 6-in/4-out audio interface (driver required for Windows).

- **Useful operation features**

Other convenient functions include a slate tone that can be used to confirm a specific level, a delay that can be set for each input separately and pre-recording up to 6 seconds.

- **ZOOM mic capsules can be connected**

A ZOOM mic capsule can be used for Input 5/6.

Please read this manual carefully to fully understand the functions of the **F4** so that you can make the most of it for many years.

After reading this manual, please keep it with the warranty in a safe place.

Names of parts

Front

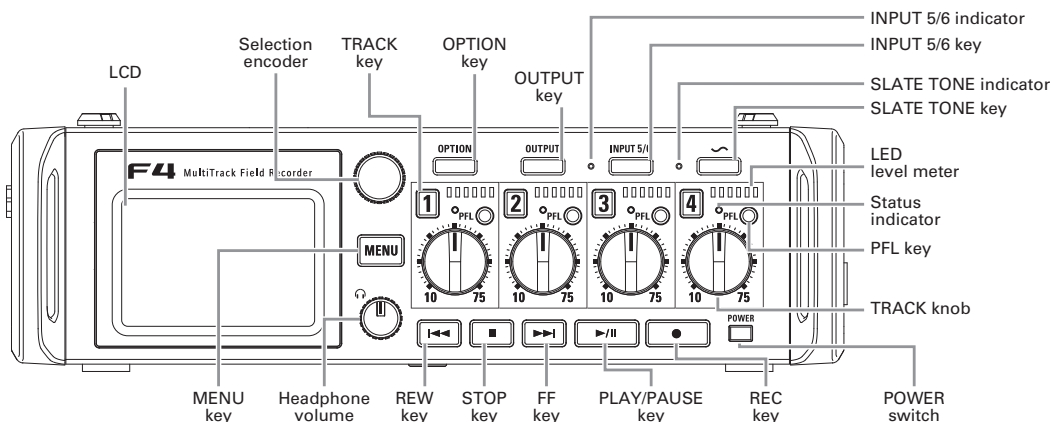

LED level meter

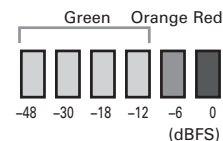

Back

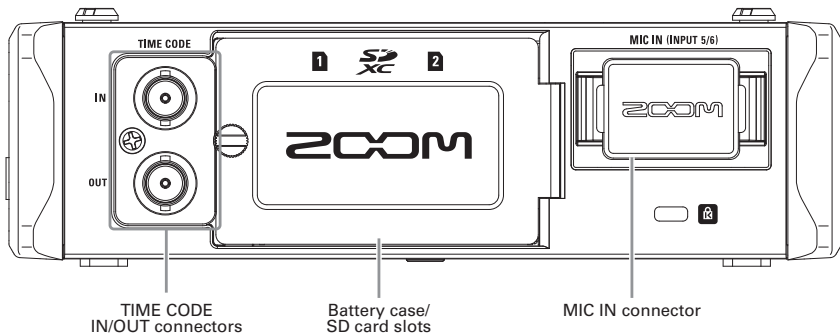

Left side

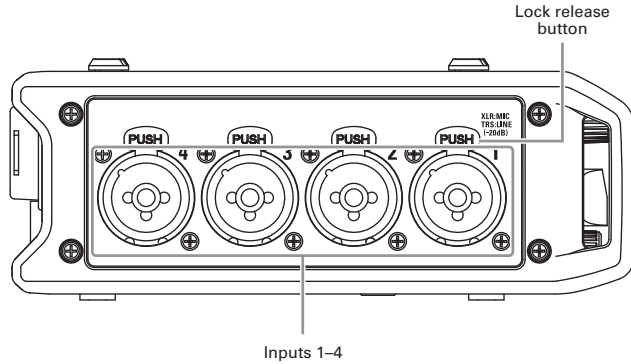

Right side

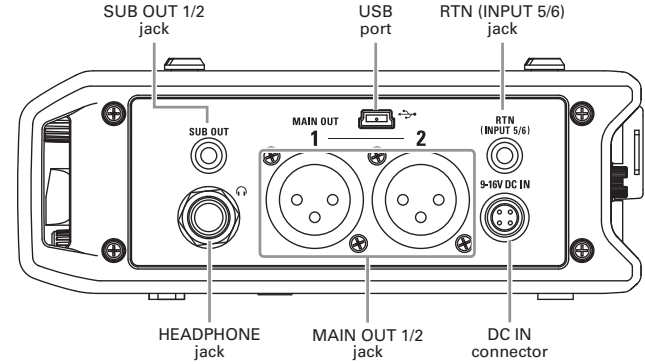

DC IN

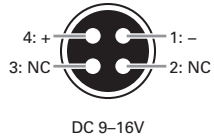

HIROSE 4-pin

Inputs 1-4

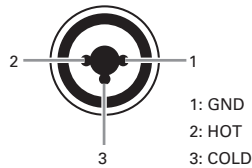

XLR

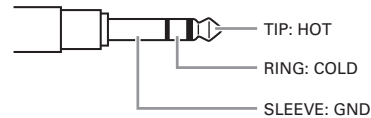

TRS

MAIN OUT 1/2

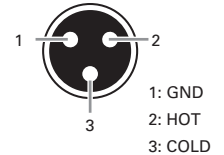

XLR

Connecting mics/other devices to Inputs 1-6

The **F4** can record 6 individual tracks that correspond to Inputs 1-6 and a stereo mix of these inputs with left and right tracks for a total of 8 tracks.

You can connect mics, and the outputs of audiovisual equipment, for example, to Inputs 1-6 and record them to tracks 1-6. In addition, Input 5/6 also supports input from a mic capsule connected to the MIC IN connector.

Connecting mics

Connect dynamic and condenser mics with XLR plugs to Inputs 1-4.

Phantom power (+24V/+48V) can be supplied to condenser mics. (→ P.80)

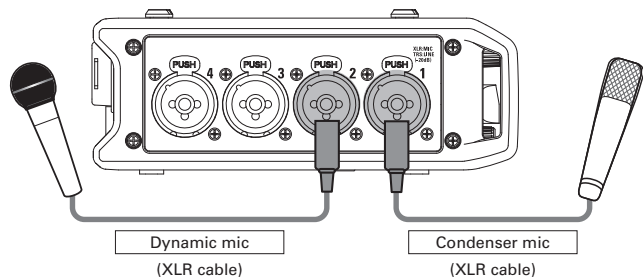

NOTE

When disconnecting a mic, pull the XLR plug while pushing the connector lock release button.

Connecting line level equipment

Connect the TRS plugs of keyboards and mixers directly to Inputs 1-4.

Direct input of passive guitars and basses is not supported. Connect these instruments through a mixer or effects device.

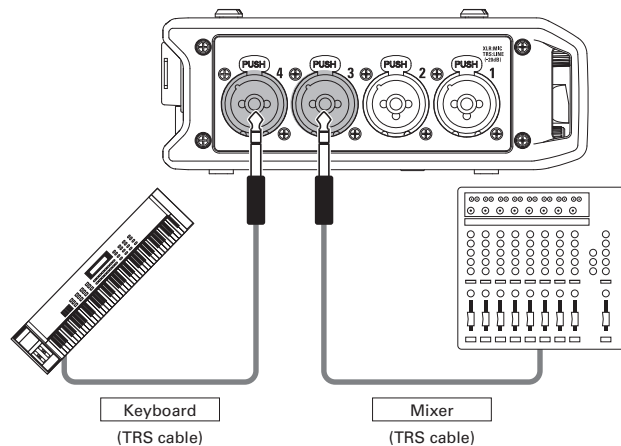

Connecting output from a camera

Use Input 5/6 when connecting output from a camera. Input 5/6 can be used as a return (RTN), enabling camera output to be monitored through the **F4** without recording (→ P.88).

Connecting mic capsules

A mic capsule can be connected to the MIC IN connector on the back of the **F4**.

NOTE

- The mic capsule input is assigned to tracks 5/6.
- When a mic capsule is connected, the RTN (INPUT 5/6) jack cannot be used.

Connecting and disconnecting mic capsules

1. Remove the protective caps from the **F4** and the mic capsule or extension cable.

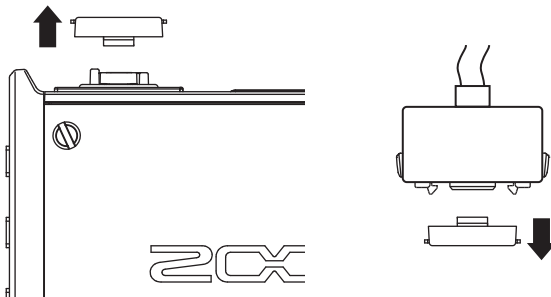

2. While pressing the buttons on the sides of the mic capsule or extension cable, connect it to the main unit, inserting it completely.

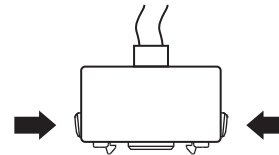

3. To disconnect the mic capsule or extension cable, pull it away from the main unit while pressing the buttons on its sides.

NOTE

- Do not use too much force when disconnecting. Doing so could damage the mic capsule or extension cable and the main unit.
- Attach the protective cap when no mic capsule will be connected for a long time.

Stereo input

By enabling the stereo link for tracks 1/2 or 3/4, the corresponding Inputs (1/2 or 3/4) can be handled as a stereo pair. (→ P.26)

When linked, Input 1 or 3 will be the left channel and Input 2 or 4 will be the right channel.

Connecting mics/other devices to Inputs 1-6 (continued)

Connection examples

Recording is possible in a variety of situations like these.

While filming

- Input 1: gun mic for main subject sound (XLR connection)
- Inputs 2-3: lapel mics for performers (TRS connections)
- Input 4: mic for ambient sound (XLR connection)
- RTN (Input 5/6): line input for camera output (stereo mini connection)

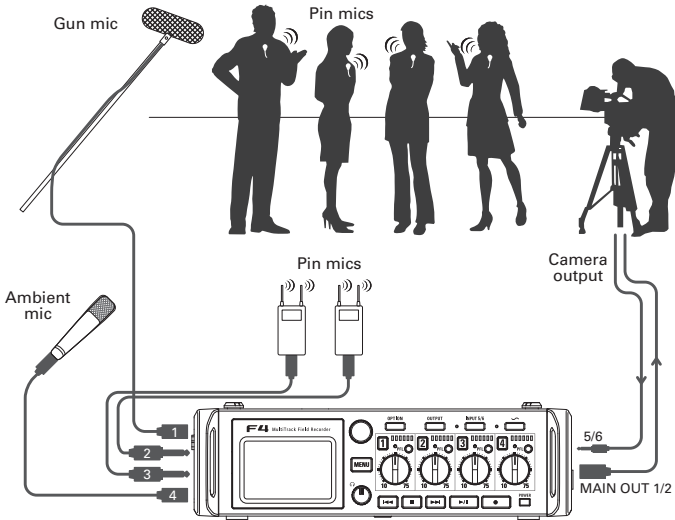

Concert recording

- Inputs 1-2: mics for stage performance (XLR connections)
- Inputs 3-4: Line inputs for outputs from mixer (TRS connections)
- Inputs 5-6: ZOOM mic capsule for audience voices (connected to MIC IN)

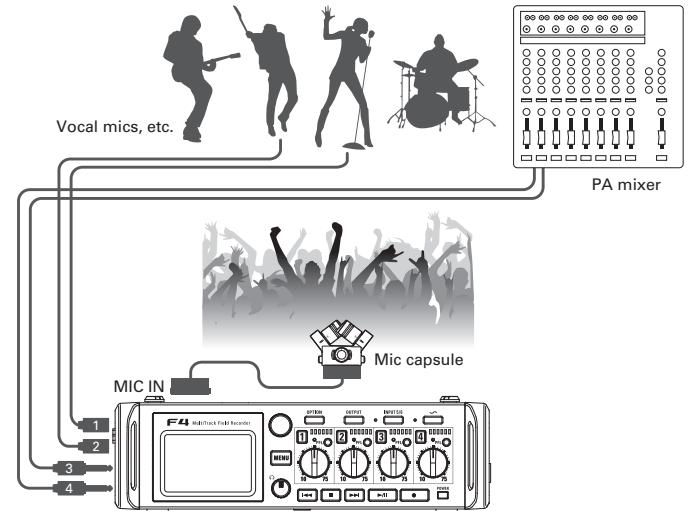

LCD display

Home Screen

Mixer

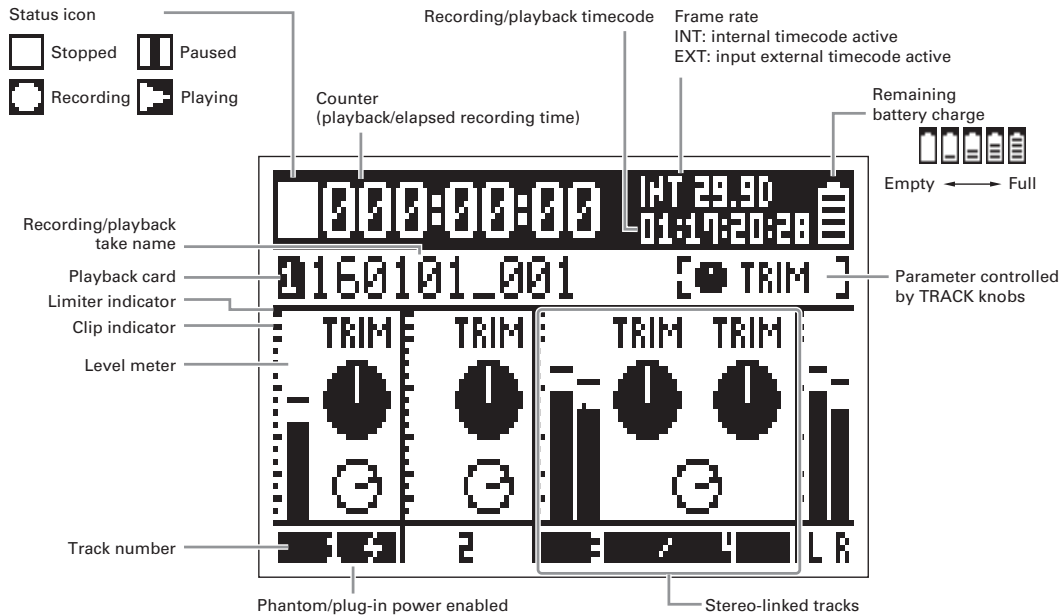

HINT

- Stereo-linked tracks are shown together like "3/4".
- When the Home Screen is not open, press and hold **MENU** to return to the Home Screen.

LCD display (continued)

■ Level meters

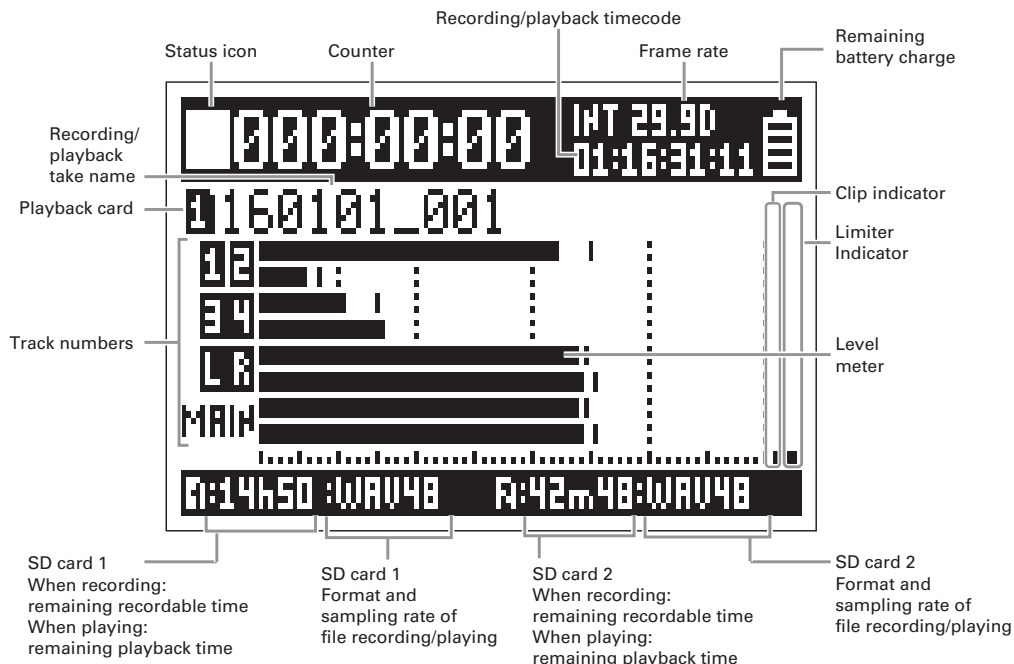

NOTE

Turn  to switch between showing the mixer (Tracks 1–4) and a set level meter View 1–4 (→ P.135) on the display..

Character input screen

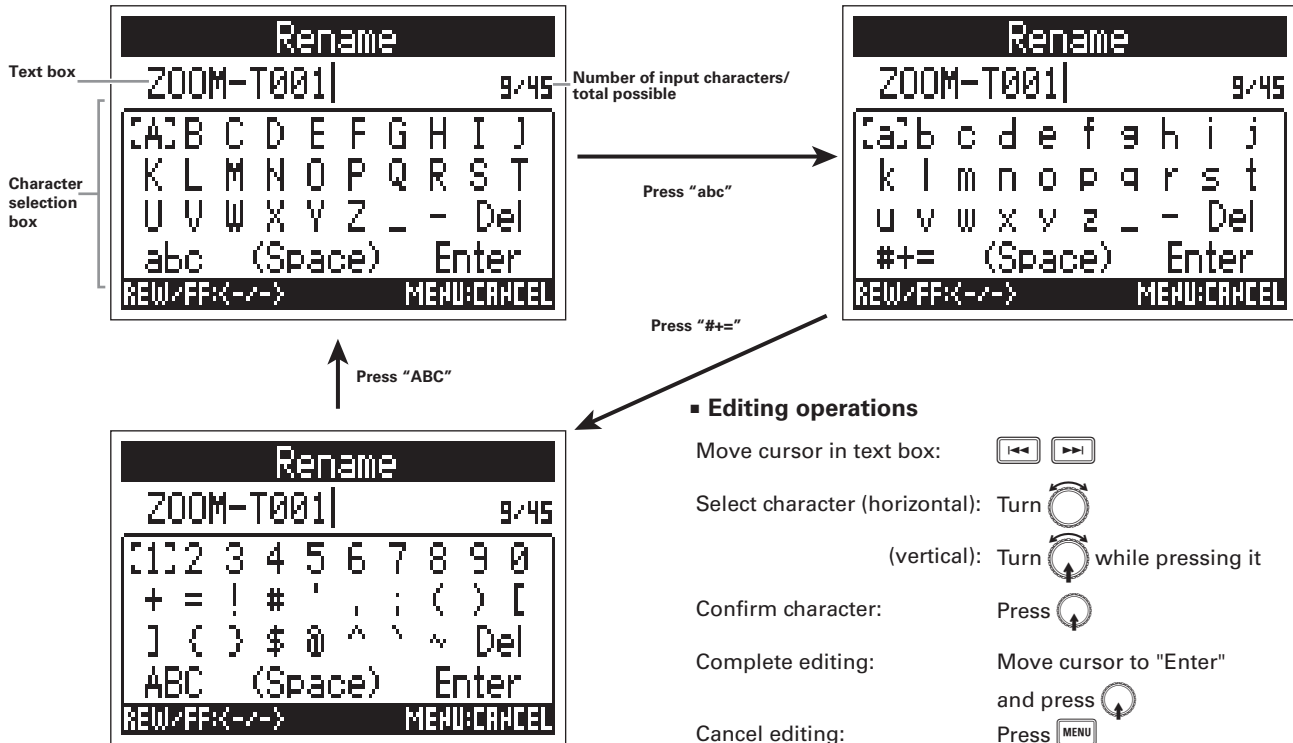

LCD display

NOTE

- The following characters can be used in project names.
- (space)!#\$%&'()*+,-0123456789;=@ABCDEFGHIJKLMN OPQRST UVWXYZ[]^_`abcdefghijklmnopqrstuvwxyz{~

HINT

- Press + to delete the previous character.
- Press + to move the cursor to "Enter".

Supplying power

Using AA batteries

1. Turn the power off and then loosen the screw to open the battery compartment cover.

2. Remove the battery case from the battery slot.

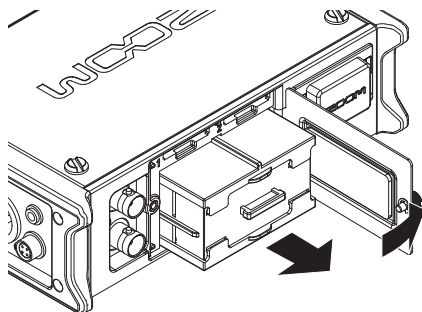

3. Open the battery case cover.

4. Install the batteries.

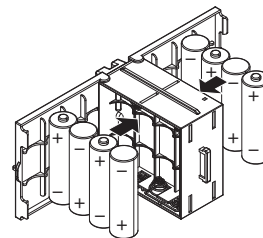

5. Close the battery case cover.

6. Load the battery case.

NOTE

Load the case so that the side with the protruding rail is up.

7. Close the battery compartment cover and tighten the screw.

NOTE

- Be careful because the battery case could become loose unexpectedly if the battery compartment cover screw is not tightened firmly.
- Use only one type of batteries (alkaline, NiMH or lithium) at a time.
- After loading batteries, set "Power Source" to the correct type of battery. (→ P.20)
- If the remaining battery power indicator becomes empty, turn the power off immediately and install new batteries.

Using a DC power supply

- 1. Connect the DC power supply device to the [DC IN] connector.**

Connect a 9–16V direct-current power supply.

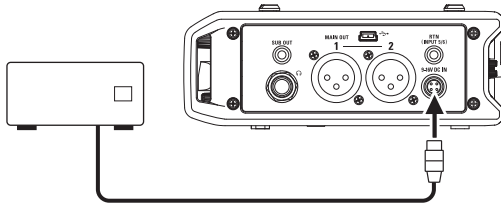

- 2. If using an adapter, plug it into an outlet.**

NOTE

- When connecting a DC power supply, be sure to make the power supply settings. (→ P.20)

Loading SD cards

1. Turn the power off and then open the SD card slot cover.

2. Insert the SD card into SD CARD slot 1 or 2.

To eject an SD card:

Push the card further into the slot and then pull it out.

NOTE

- Always turn the power off before inserting or removing an SD card.
Inserting or removing a card while the power is on could result in data loss.
- When inserting an SD card, be sure to insert the correct end with the top side up as shown.
- If an SD card is not loaded, recording and playback are not possible.
- To format an SD card, see P.144.

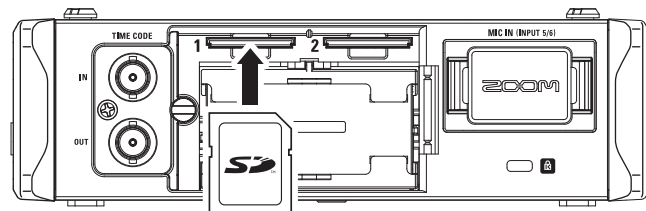

Turning the power on and off

Turning the power on

1. Press and hold  briefly.

The  LED will light.

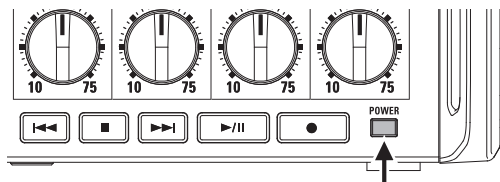

NOTE

- The first time you turn the power on after purchase, you must set the date/time (→ P.18). You can also change this setting later.
- If “No Card!” appears on the display, confirm that an SD card is inserted properly.
- If “Protected!” appears on the display, the SD card write-protection is enabled. Slide the lock switch on the SD card to disable write-protection.
- If “Invalid Card!” appears on the display, the card is not formatted correctly. Format the card or use a different card. To format an SD card, see P.144

Turning the power off

1. Press and hold  briefly.

NOTE

Keep pressing it until the ZOOM logo appears on the LCD.

Disabling the Auto Power Off function

The power will automatically turn off if the **F4** is unused for 10 hours. If you want the power to stay on always, disable the automatic power saving function.

1. Press .

2. Use  to select SYSTEM, and press .

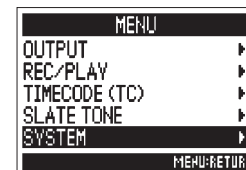

3. Use  to select Auto Power Off, and press .

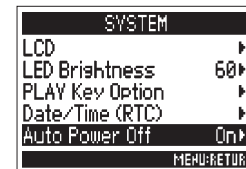

4. Use  to select Off, and press .

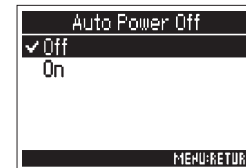



Setting the date and time (Date/Time (RTC))

The date and time set on the **F4** are used when recording files, for example. You can set the date format (order of year, month and day).

1. Press .

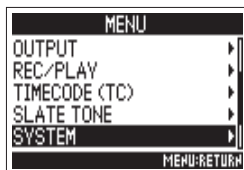
2. Use  to select SYSTEM, and press .



3. Use  to select Date/Time (RTC), and press .

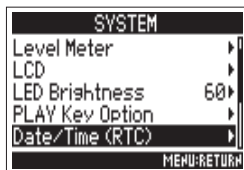

► Continue to one of the following procedures.

| | |
|--------------------------------|------|
| Setting the date and time..... | P.18 |
| Setting the date format | P.19 |

Setting the date and time

4. Use  to select Set Date/Time, and press .



5. Change the setting.

- Changing settings

Move cursor or change value:

Turn .

Select item to change: Press .



Note: The first time you turn the power on after purchase, you must set the date/time.

6. Use  to select Enter, and press .

This completes setting the date and time.

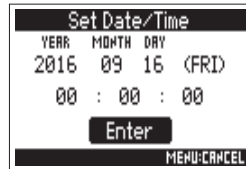

Setting the date format

4. Use  to select Data Format, and press .

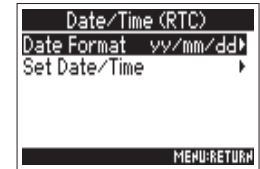

5. Use  to select the format, and press .

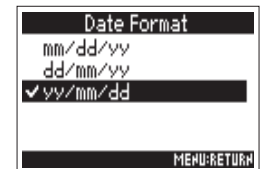

| Setting value | Explanation |
|---------------|------------------------|
| mm/dd/yy | Month, day, year order |
| dd/mm/yy | Day, month, year order |
| yy/mm/dd | Year, month, day order |

Setting the power supply used (Power Source)



Set the DC power supply shutdown voltage, nominal voltage and type of batteries so that the remaining power supply charge can be shown accurately.

On this menu page, you can check the voltage of each power supply and the remaining battery capacity.

1. Press .

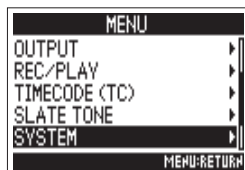
2. Use  to select **SYSTEM**, and press .



3. Use  to select **Power Source**, and press .

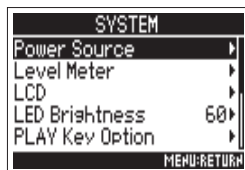



► Continue to one of the following procedures.

| | |
|--|------|
| Setting the DC power supply (DC IN) shutdown voltage | P.20 |
| Setting the DC power supply (DC IN) nominal voltage | P.21 |
| Setting the type of AA batteries (Int AA) | P.21 |

Setting the DC power supply (DC IN) shutdown voltage

If the voltage becomes less than the value set here when using a DC power supply, the **F4** will automatically stop recording and turn off.

If AA batteries (Int AA) are installed, however, the power supply will switch to them and operation will continue.

4. Use  to select **Shutdown Voltage**, and press .

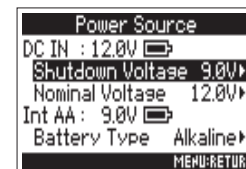



HINT

- The shutdown voltage is the voltage level that the external DC power supply runs out and can no longer supply power.
- See the DC power supply manual for the shutdown voltage value.

5. Use  to select the voltage, and press .



Setting the DC power supply (DC IN) nominal voltage

4. Use  to select Nominal Voltage, and press .

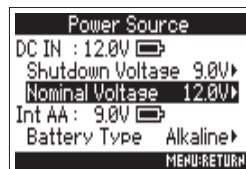

5. Use  to select the voltage, and press .

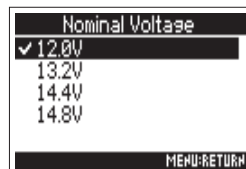

HINT

- The nominal voltage is the voltage of the DC power supply under normal conditions. This value should be indicated on the exterior of the DC power supply.

Setting the type of AA batteries (Int AA)

4. Use  to select Battery Type, and press .

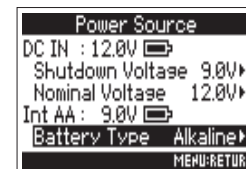

5. Use  to select the type, and press .

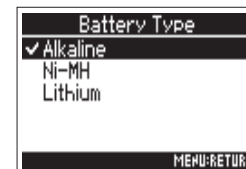

NOTE

- When multiple power supplies are connected, they will be used in the following order of priority.
 - DC power supply (DC IN)
 - AA batteries (Int AA)
- The voltages of each power supply are shown on the display.

Recording process

Follow the process below to record with the **F4**.
The data created for each recording occurrence is called a "take".

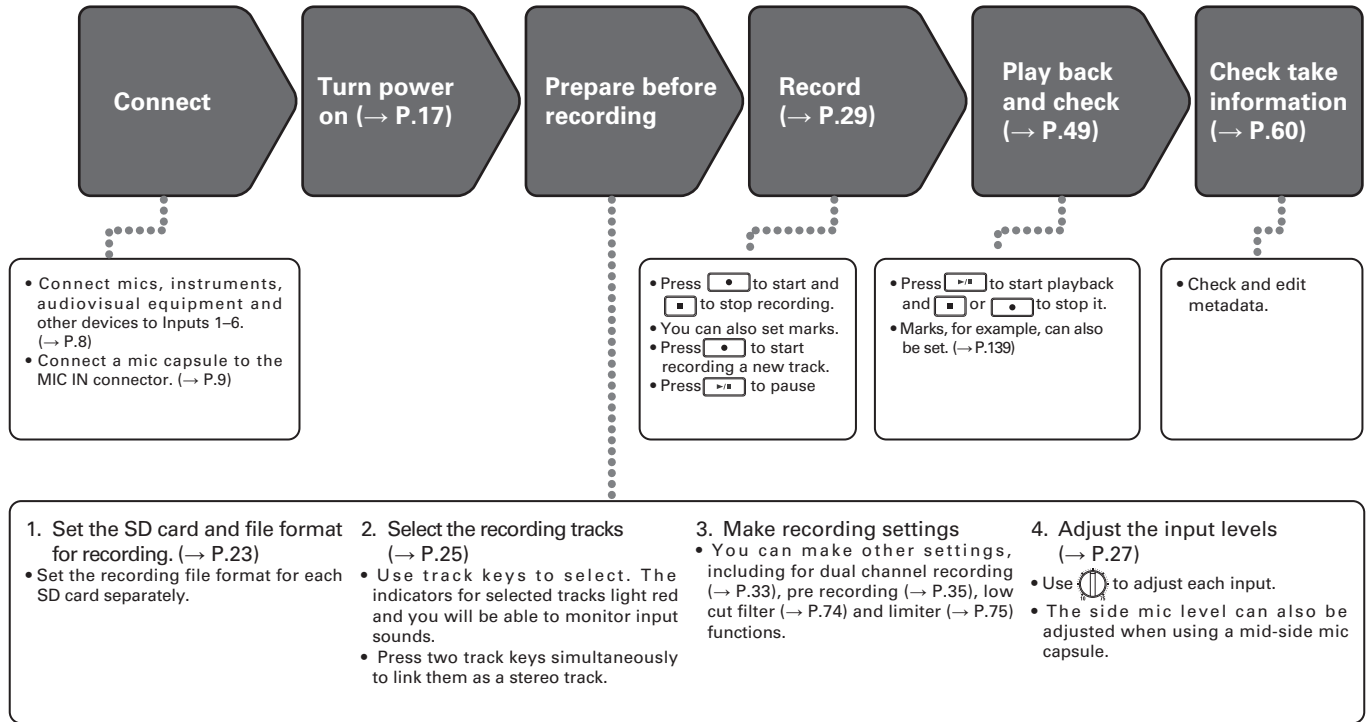

Setting the SD card used for recording and recording file format

The recording file format can be set independently for SD card slots 1 and 2.



HINT

- By using the same settings for both card slots, recording the same contents to two cards is possible. This function can be used to create a backup in case the sound skips on one card, for example.
- You can also record tracks 1-6 unmixed on one SD card, while recording all tracks mixed together as MP3 data with left and right tracks on the other SD card.

1. Press .

2. Use  to select REC/PLAY, and press .



3. Use  to select Rec to SD1 or Rec to SD2, and press .

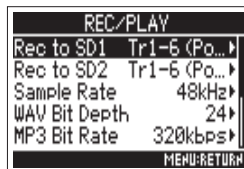

4. Use  to select the file type, and press .

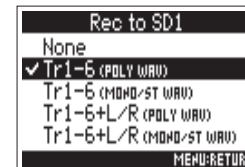

| Setting value | Tracks recorded | Explanation |
|---------------------------|---------------------|--|
| None | - | Nothing will be recorded on the SD cards. |
| Tr1-6 (POLY WAV) | Selected tracks 1-6 | A single poly file will be created that contains audio for multiple tracks. |
| Tr1-6 (MONO-ST WAV) | | A single mono file is created for each mono track and a single stereo file is created for each stereo track. |
| Tr1-6 + L/R (POLY WAV) | All selected tracks | A single poly file will be created that contains audio for multiple tracks. |
| Tr1-6 + L/R (MONO-ST WAV) | | A single mono file is created for each mono track and a single stereo file is created for each stereo track. |
| L/R (STEREO WAV) | L/R tracks | A stereo file is created based on the mix created by the internal mixer. |
| L/R (STEREO MP3) | | |

Setting the SD card used for recording and recording file format (continued)

NOTE

- When recording with a MONO/STWAV setting, the audio files are saved in a folder that is created. (→ P.37)
- When recording to 2 cards simultaneously, files will be saved in the same folder as the card set for recording and playback. Folders will be created automatically if they do not already exist.
- If recording should stop on one SD card because it runs out of space, for example, recording will continue on the other SD card. At such times, do not remove the card that has stopped recording from the slot. Doing so could damage the card or data.

Selecting inputs

You can select which among Inputs 1–6 to use.

Inputs will be recorded on tracks with the same numbers. For example, Input 1 will be recorded on track 1 and Input 2 will be recorded on track 2.

Selecting inputs

1. Press the track key with the same number as the input you want to record, making the track indicator light.

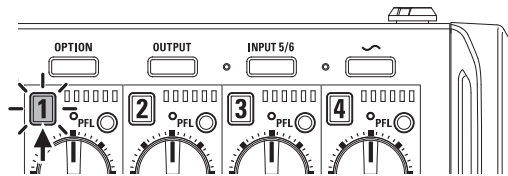

NOTE

The signals from the inputs selected this way will also be sent to the L/R tracks.

Selecting Input 5/6

1. Press .
2. Use to select INPUT, and press .
3. Use to select ON, and press .

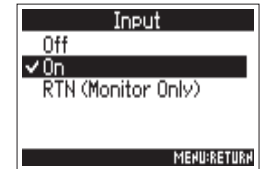
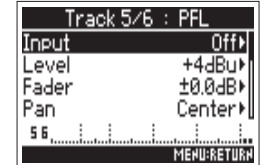

HINT

- INPUT 5/6 can be used as a return (RTN) so you can monitor the input by headphones. (→ P.88)
- You can also press and hold [INPUT 5/6] to turn it On/Off.

Selecting inputs (continued)

Linking inputs as a stereo pair

1. While pressing track key **1**, press track key **2**.

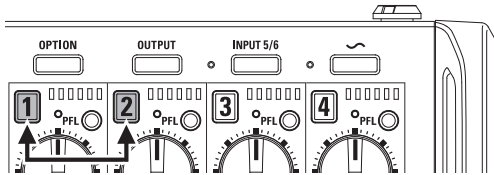

Tracks 1 and 2 will be joined as a stereo track (stereo link).
Repeat the same procedure to disable the stereo link.

HINT

- The 3/4 track pair can also be stereo linked in the same way.
- When a mic capsule that allows independent L and R input selection is connected, stereo-linking can also be enabled and disabled for their tracks.
- Tracks 5 and 6 are always stereo linked.



Adjusting the input levels and monitoring balance

You can adjust the input levels (TRIM) and monitoring levels (FADER) of each track.

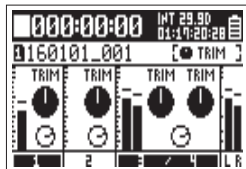
1. Open the mixer on the Home Screen. (→ P.11)



2. Press .

3. Use  to select the parameter you want to adjust, and press .

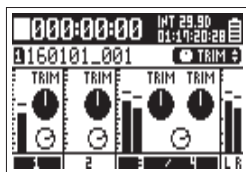

HINT

You can select TRIM or FADER.

4. Use  for the track you want to adjust to change the parameter value.

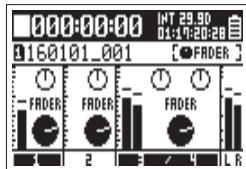

The selected parameter value changes in response to the operation of .





HINT

The position of the knob on the display always shows the current setting.

NOTE

After changing the parameter to be adjusted, for example, if the positions of  and the knob on the display are different, moving  will not affect that setting.

In this case, if you adjust  to match the position of the knob on the display, the display knob and  will be relinked, and you will be able to use it to adjust the setting value again.





| Parameter | Setting range | Explanation |
|-----------|---|------------------------------------|
| TRIM | Input connected using XLR plug (Mic): +10–+75 dB Input connected using TRS plug (Line): –10–+55 dB | This adjusts the input level. |
| FADER | Mute, –48.0 – +12.0 dB | This adjusts the monitoring level. |

NOTE

- These monitoring level settings only affect the output signals. They have no effect on recorded data.
- Monitoring level settings are saved separately for each take. They can be changed during playback. (→ P.50)
- Mix settings are not saved with the take when the recorded file format is MP3.

Adjusting the input levels and monitoring balance (continued)

HINT

- If the sound distorts even when you lower the input level, try changing mic positions and adjusting the output levels of connected devices.
- You can set the standard input level for INPUT (5/6) in advance.
- Press  + PFL  (Track 1) to disable adjustment of input levels by turning  for all tracks.
- Press  + PFL  (Track 1) again to cancel this.
- Set PAN values on the PFL screen.

Recording

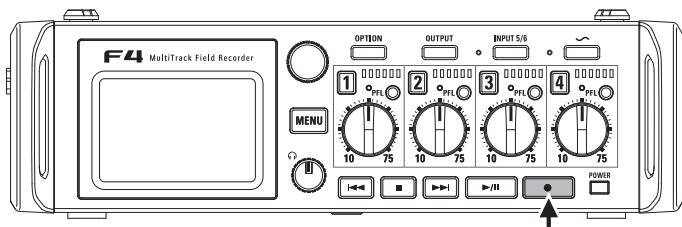

1. Press .

This starts recording.

HINT

If the timecode function is enabled, recording will start from frame 00 (00 or 02 when using drop frame) and the file length will always be a full second value. This makes synchronization easy when editing later.

2. Press to start a new take while recording.

This will end the current take and start a new take while continuing to record without interruption.

NOTE



Pressing  during recording only functions after recording for at least a second.

3. Press to pause.

NOTE

- Pausing will actually occur at a whole second increment.
- When recording is paused, a mark is added at that point. Press  to resume recording.
- A maximum of 99 marks can be added to a take.

HINT

- During playback, you can use  and  to jump to places where marks have been added.
- You can also add marks without pausing. (→ P.139)

4. Press to stop.

NOTE

- If the maximum file size is exceeded during recording (→ P.36), recording will continue in a new take with a number that is one higher. No gap in sound will occur between the two takes when this happens.
- When recording on two SD cards simultaneously, if recording should stop on one because it runs out of space, recording will continue on the other SD card without interruption.

HINT

- Press and hold  when the Home Screen is open to check the name and track of the next take recorded.
- Files are automatically saved at regular intervals during recording. Even if the power is interrupted or another problem occurs during recording, an affected file can be restored to normal by playing it with the **F4**.

Setting the sampling rate (Sample Rate)

You can set the sampling rate used to record files.



1. Press .

2. Use  to select REC/PLAY, and press .

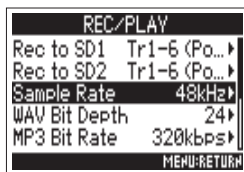

3. Use  to select Sample Rate, and press .



4. Use  to select the sampling rate, and press .

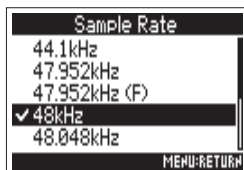

| Setting value | Explanation |
|--|--|
| 44.1kHz, 48kHz, 88.2kHz, 96kHz, 192kHz | These are standard sampling rates. |
| 47.952kHz | Select this when recording video at 23.976 frames per second if you want to edit at 24 frames per second later. |
| 48.048kHz | Select this when recording video at 24 frames per second if you want to edit at NTSC 29.97 or 23.98 HD later. |
| 47.952kHz(F), 48.048kHz(F) | These function the same as the two above, but the sampling rate metadata will be recorded as 48kHz for <FILE_SAMPLE_RATE>. This enables playback and editing with devices and software that do not support 47.952kHz and 48.048kHz WAV files. Playback, however, will occur at the ±0.1% speed at which the file was recorded. |

NOTE

- When the recording file format is MP3, only 44.1kHz and 48kHz can be selected.
- When 192kHz is selected, Input Delay and Output Delay are disabled.



Setting WAV file bit depth (WAV Bit Depth)

You can set the bit depth of WAV files.

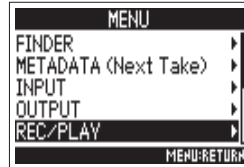

1. Press .

2. Use  to select REC/PLAY, and press .

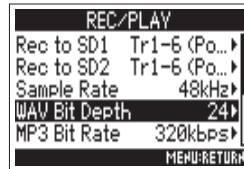

3. Use  to select WAV Bit Depth, and press .



4. Use  to select the bit depth, and press .

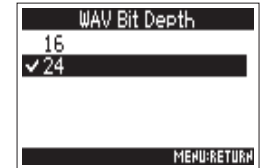

HINT

This can be set to 16-bit or 24-bit.

Setting MP3 file bit depth (MP3 Bit Rate)

You can set the bit rate of recorded MP3 files.

1. Press .

2. Use  to select REC/PLAY, and press .



3. Use  to select MP3 Bit Rate, and press .

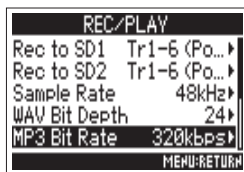

4. Use  to select the bit rate, and press .

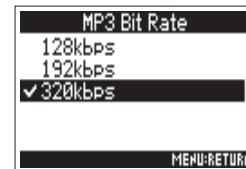

HINT

This can be set to 128 kbps, 192 kbps or 320 kbps.

Recording two tracks at different levels (Dual Channel Rec)

In addition to the regular recording, the **F4** can record another recording adjusted to a different input level (dual channel recording).

For example, by using dual channel recording to record at an input level 12 dB below the regular recording, you can prepare a replacement if the regular recording distorts because the track level is too high.

Dual channel recording can be used with tracks 1–2.

1. Press .

2. Use  to select REC/PLAY, and press .

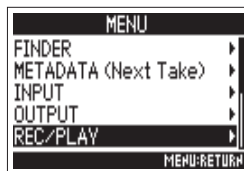

3. Use  to select Dual Channel Rec, and press .

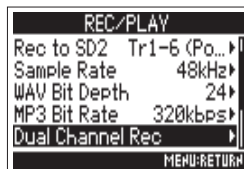

4. Use  to select the track, and press .

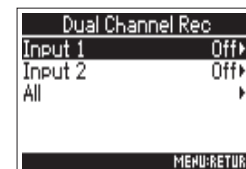

5. Use  to select On, and press .

When dual channel recording is On, the name of the corresponding second track (3 or 4) changes.

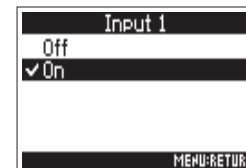

Recording two tracks at different levels (Dual Channel Rec) (continued)

6. Turn for the dual channel recording track to adjust the input level.

See "Adjusting the input levels and monitoring balance" (→ P.27) for how to adjust input levels.

When Track 1 is selected, use  for Track 3 to adjust.



HINT

Dual channel recording increases the amount of space used on SD cards.

NOTE

- When using dual channel recording, the track that is numbered 2 higher than the original track is used for the second recording. For example, track 3 is used for the dual channel recording of track 1 and track 4 is used for track 2. Dual channel recording tracks cannot be used independently.
- When dual channel recording is enabled, if stereo-linking is enabled or disabled for tracks 1/2, the same setting will be applied to tracks 3/4.
- The limiter, high pass filter and other functions can be set independently for the regular and dual recording tracks.



Capturing audio before recording starts (Pre Rec)

The input signal is always buffered for a set amount of time, so it can be captured for up to 6 seconds before  is pushed (pre-recording). This is useful when  is pressed late, for example.

1. Press .

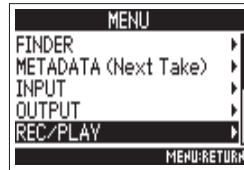
2. Use  to select REC/PLAY, and press .



3. Use  to select Pre Rec, and press .

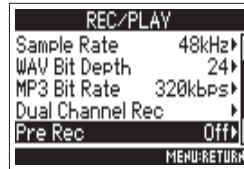

4. Use  to select On, and press .



The maximum pre-recording time depends on the file format and sampling rate used.

| File format | Sampling rate | Maximum pre-recording time |
|-------------|---------------|----------------------------|
| WAV | 44.1kHz | 6 seconds |
| | 47.952kHz | 6 seconds |
| | 47.952kHz(F) | 6 seconds |
| | 48kHz | 6 seconds |
| | 48.048kHz | 6 seconds |
| | 48.048kHz(F) | 6 seconds |
| MP3 | 88.2kHz | 3 seconds |
| | 96kHz | 3 seconds |
| | 192kHz | 1 second |
| | 44.1kHz | 6 seconds |
| | 48kHz | 6 seconds |

Setting the maximum file size (File Max Size)

The maximum size of recording files can be set. If a recording file exceeds the maximum file size, recording will continue in a new take with a number that is one higher. No gap in sound will occur between the two takes when this happens.

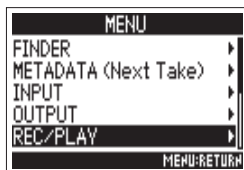

1. Press .

2. Use  to select REC/PLAY, and press .



3. Use  to select File Max Size, and press .



4. Use  to select the maximum size of recording files, and press .

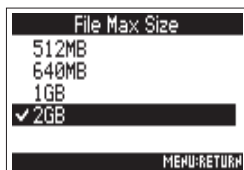

HINT

Setting the maximum size to 640MB or 512MB is convenient for backing up to CDs.

Folder and file structure

When recording with the **F4**, folders and files are created on SD cards in the following manner.

Folders and files on the **F4** are used to manage scenes and takes as a rule.

The folder and file structure differs according to the recording file format. In addition, the names of folders and files depend on how scenes are named.

HINT

Take: This is a unit of data created for a single recording.

Scene: This is a unit containing multiple files and takes that comprise a single scene.

NOTE

- Setting the SD card used for recording and recording file format (→ P.23)
- Setting how scenes are named (mode) (→ P.42)

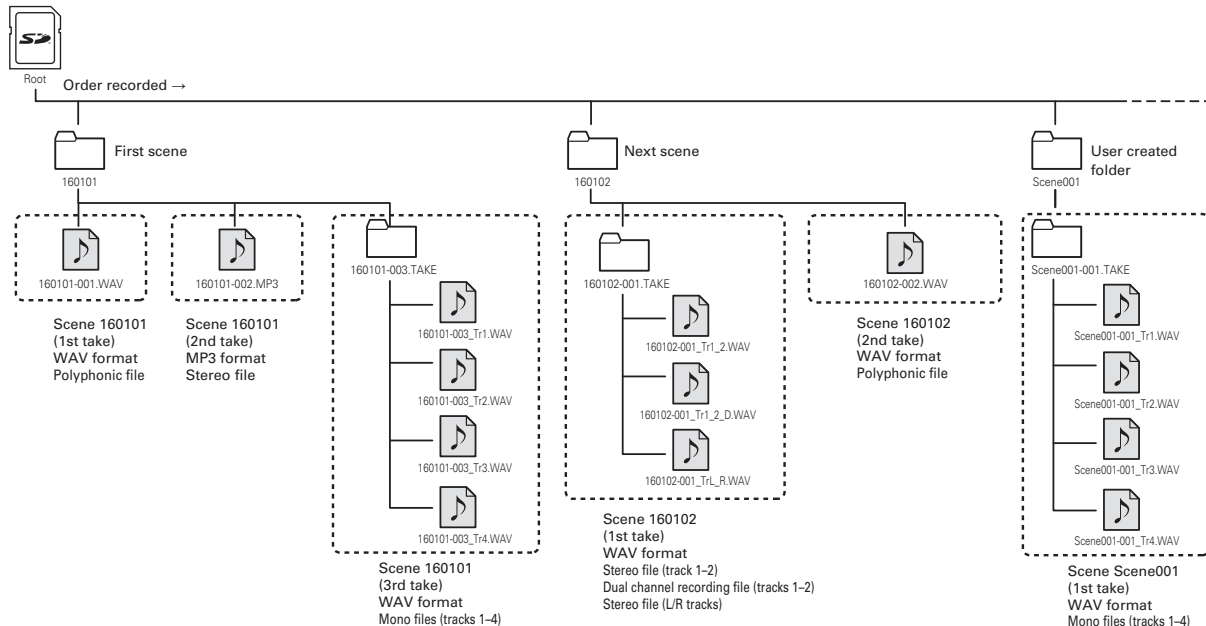

Folder and file structure (continued)

Take names

| Structure | Explanation |
|-----------|---|
| | <p>Scene name: Select none, the folder name, the date or a name input by the user (→ P.42).</p> <p>Scene number: Press + to advance the number by one.</p> <p>Take number: This number increases by 1 with each recording made with the same scene name and scene number.</p> |

Audio file name

File names given by the **F4** differ according to polyphonic, mono and stereo file formats. Track numbers and other data are added to file names.

File names

File names are given according in the following formats.

| Type | Structure | Explanation |
|-----------------------------|-----------|---|
| Poly file | | This is a file created by polyphonic recording. Audio for multiple tracks is recorded to a single file. |
| Mono file | | This is a file created by monophonic recording. |
| Stereo file | | This is a file created by stereophonic recording. |
| Dual channel recording file | | This is a file created by dual channel recording. |

HINT

When recording with a MONO/ST WAV setting, the audio files are saved in a take folder that is created.

Moving the previously recorded take to the FALSETAKE folder

If the just recorded take was a failure, you can use a shortcut to move the recording to the FALSETAKE folder.

1. Open the Home Screen.

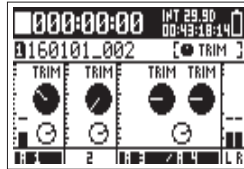

2. Press and hold .

HINT

- Moving a take to the FALSETAKE folder reduces the take number by one.
- You can move the previously recorded take to the FALSE TAKE folder even during recording.

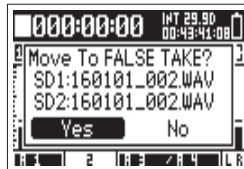

3. Use  to select "Yes",
and press .



Changing the note for the next take recorded (Note)

You can input characters for a note to use as metadata in the file.

1. Press .

2. Use  to select METADATA (Next Take), and press .

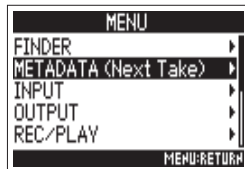

3. Use  to select Note, and press .

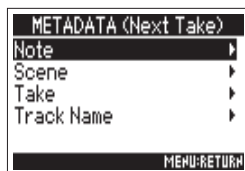

► Continue to one of the following procedures.

Editing notes P.40

Selecting notes from the history list P.41

Editing notes

4. Use  to select Edit, and press .



5. Edit the note.

See "Character input screen" (→ P.13) for how to input characters.





NOTE

This note is written to the <NOTE> metadata.

Selecting notes from the history list

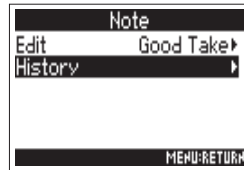
4. Use  to select History, and press .



5. Use  to select the History item to use, and press .





NOTE

The history list will be erased if the Factory Reset function is used.

Setting how recorded scenes are named and numbered (Scene)

You can set how scenes are named (name mode), the base scene name and how scene numbers advance.

1. Press .

2. Use  to select METADATA (Next Take), and press .

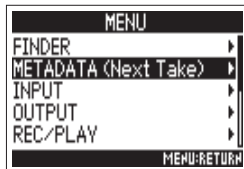

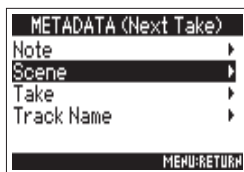

3. Use  to select Scene, and press .



► Continue to one of the following procedures.

| | |
|--|------|
| Setting how scenes are named (mode) | P.42 |
| Editing the scene name | P.43 |
| Selecting a scene name from the history list | P.44 |
| Setting how scene numbers advance | P.44 |





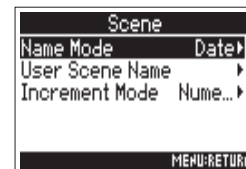

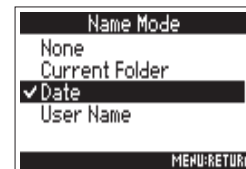

Setting how scenes are named (mode)

4. Use  to select Name Mode, and press .



5. Use  to select the mode, and press .



| Setting value | Explanation |
|----------------|---|
| None | The scene name and number are not used. When recording files are created, they are named only with the take number, such as "001", "002", "003" and so on.  +  cannot be used to advance the scene number by one. Example: 001.wav |
| Current Folder | The name of the currently selected folder is used as the scene name.  +  can be used to advance the scene number by one. After advancing the scene number by 1, the corresponding folder will be used as the recording destination. If that folder does not already exist, it will be created. Example: Folder001_001.wav |
| Date | The date is used as the scene name.  +  cannot be used to advance the scene number by one. If recording occurs after the date changes, a scene folder with the date will be created. Example: 20160101_001.wav |
| User Name | A scene name input by the user is used.  +  can be used to advance the scene number by one. No folder is created in this case. Example: MYSCENE001_001.wav |

Editing the scene name

If Scene Name Mode is set to User Name (→ P.42), the scene name edited here is used.

4. Use to select User Scene

Name, and press .

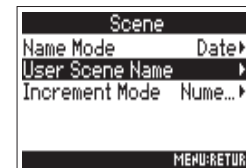

5. Use to select Edit,

and press .



6. Changing scene names

See "Character input screen" (→ P.13) for how to input characters.





NOTE

The scene name is written to the <SCENE> metadata. You cannot put a space or an @ mark at the beginning of the name.

Setting how recorded scenes are named and numbered (Scene) (continued)

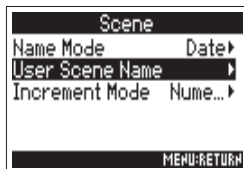

Selecting a scene name from the history list

4. Use  to select User Scene Name, and press .

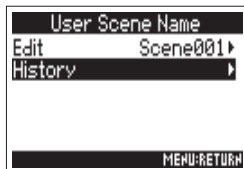

5. Use  to select History, and press .



6. Use  to select the History item to use, and press .





NOTE



The history list will be erased if the Factory Reset function is used.

Setting how scene numbers advance (Scene Increment Mode)



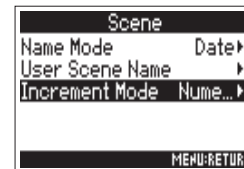

On the Home Screen,  +  can be used to advance the scene number by one. Set how this number advances.

4. Use  to select Increment Mode, and press .

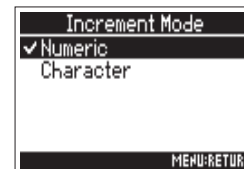

5. Use  to select how scene numbers advance, and press .



| Setting value | Explanation |
|---------------|---|
| Numeric | Press  +  on the Home Screen to increase the scene number by one. Example: Scene → Scene1 → Scene2 → ... → Scene9999 |
| Character | Press  +  on the Home Screen to advance the capital letter at the end of the scene name by one. If the scene name does not have a capital letter at its end, one will be added. Example: Scene1 → Scene1A → Scene1B → ... → Scene1Z → Scene1AA → Scene1AB → ... |

Setting the take reset condition and numbering format (Take)

You can set the take number reset condition and take number format used when recording.

1. Press .

2. Use  to select METADATA (Next Take), and press .





3. Use  to select Take, and press .



Setting the take number reset condition

4. Use  to select Reset Mode, and press .



5. Use  to select the reset mode, and press .

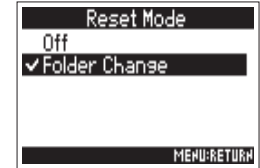

▶ Continue to one of the following procedures.



Setting the take number reset condition P.45

Setting the take number format P.46

| Setting value | Explanation |
|---------------|--|
| Off | The take number will not be reset. However, if the folder is changed and that folder contains a number higher than the current take number, the take number will be set to one higher than the highest existing take number. |
| Folder Change | If the destination folder is changed, the take number will be set to one higher than the highest take number in that folder. |

Setting the take reset condition and numbering format (Take) (continued)

Setting the take number format

4. Use  to select Number Format, and press .



5. Use  to select the format, and press .

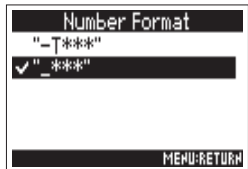



| Setting value | Take formats |
|---------------|---|
| "-T***" | <p>"Scene"-T***</p> <ul style="list-style-type: none"> ├── Take number └── Scene name <p>Example: Scene001-T001</p> |
| "_ ***" | <p>"Scene"-T***</p> <ul style="list-style-type: none"> ├── Take number └── Scene name <p>Example: Scene001_001</p> |

Changing the track name of the next take recorded (Track Name)

The track name set with the following procedure will be given to the next recorded track.

1. Press .



2. Use  to select METADATA (Next Take), and press .



3. Use  to select Track Name, and press .



HINT

On the Home Screen,  +  can be used to open the Track Name screen.

4. Use  to select the track, and press .

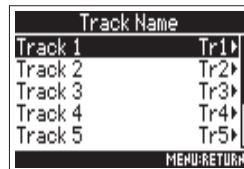

► Continue to one of the following procedures.

Editing the track name..... P.48

Selecting a track name from the History list P.48

Changing the track name of the next take recorded (Track Name) (continued)

Editing the track name

5. Use  to select Edit, and press .



6. Edit the track name.

See "Character input screen" (→ P.13) for how to input characters.

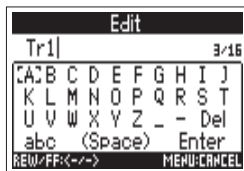



NOTE

The track name is written to the <TRACK><NAME> metadata.

Selecting a track name from the history list

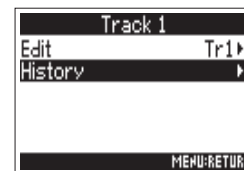
5. Use  to select History, and press .



6. Use  to select the History item to use, and press .



NOTE



The history list will be erased if the Factory Reset function is used.

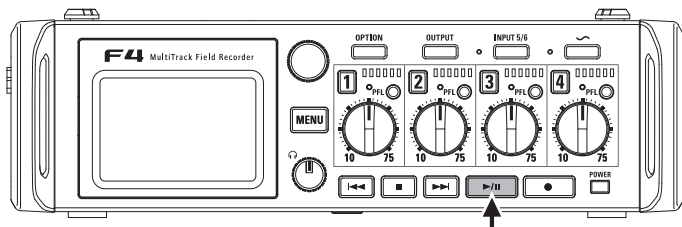

Playing recordings



1. Press .

■ Playback operations

Select playback take or Press  or 
jump to mark:



Search backward/forward: Press and hold  

Pause/resume playback: Press 

NOTE

- If a track has no playback file, no track number is shown for it.
- If 1-6 and L/R have playback tracks, the L/R tracks will not be played.

HINT

- The longer you press and hold  or , the faster the speed of searching backward/forward.
- During playback, press track keys to switch between playing back (lit green) and muted (unlit).
- An "InvalidTake!" message will appear if the selected take is not valid.
- A "NoTake!" message will appear if no playable take exists.
- During playback, you can press  to add a mark that can be used for skipping. (→ P.140)

2. Press to return to the Home Screen.

Mixing takes

You can change the volume and panning of each track during playback.

1. Open the mixer on the Home Screen. (→ P.11)

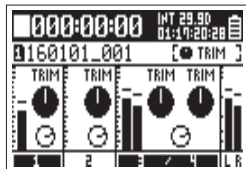

2. Press  to start playback.

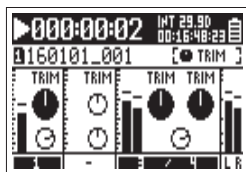

3. Adjust the parameter settings.

See "Adjusting the input levels and monitoring balance" (→ P.27) for how to change settings.

NOTE

- Settings are saved separately for each take and are used during playback.
- Mix settings are not saved with the take when the format is MP3.

Changing the playback mode (Play Mode)

You can change the playback mode.



1. Press .

2. Use  to select REC/PLAY, and press .

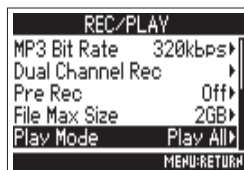

3. Use  to select Play Mode, and press .



4. Use  to select the play mode, and press .



| Setting value | Explanation |
|--|---|
| Play One (single playback) | Only the selected track will be played. |
| Play All (all playback) | Tracks will be played back continuously from the selected take until the last take. |
| Repeat One (single repeat playback) | The selected track will be played repeatedly. |
| Repeat All (all repeat playback) | All takes in the selected folder will be played repeatedly. |

Take and folder operations (Finder)

The Finder allows you to view the contents of SD cards, takes and folders and create folders. It also allows you to set and delete recording/playback folders and view their information, for example.

1. Press .

2. Use  to select FINDER, and press .

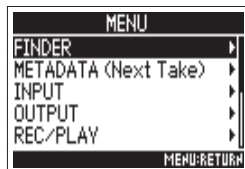

3. Turn  to select the SD card, folder or take that you want to use.

▪ Editing operations

Move cursor: Turn 

Move down a level: Press 

Move up a level: Press 

▪ SD card selected

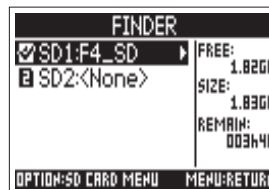

Open space

Size

Remaining recordable time

▪ Folder selected

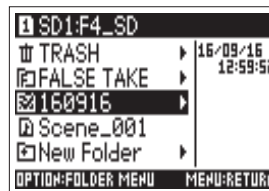

Date

Time

▪ Take selected

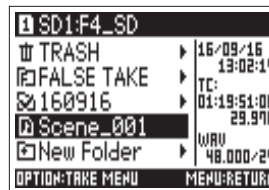

Date





Time

Timecode

Frame rate

Recording format

NOTE

- When the cursor is on a take, you can press  to play the selected take. You can also use ,  and .
- A check mark appears on the playback take and recording/playback folder.

► Continue to one of the following procedures.

| | |
|---|-----|
| Creating folders | P53 |
| Selecting the take recording/playback folder | P54 |
| Changing folder and take names | P54 |
| Checking take information | P55 |
| Checking take marks and using them for playback | P55 |
| Copying takes to other cards and folders..... | P56 |
| Deleting folders and takes | P57 |
| Emptying the TRASH/FALSE TAKE folder..... | P58 |

Creating folders

Folders can be created inside the currently selected SD card/folder.

1. Use  to select **New Folder**, and press .

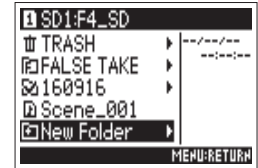

2. **Edit the folder name.**

See "Character input screen" (→ P.13) for how to input characters.

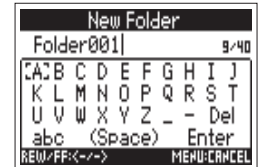

NOTE

- The folder created will be set as the recording folder.
- The name of the folder created is written to the <PROJECT> or <SCENE> metadata of the recorded take.
- You cannot put a space or an @ mark at the beginning of the name.

Take and folder operations (Finder) (continued)

Selecting the take recording/playback folder

Use this procedure to select the folder that contains the take to be played back or the folder to use for recording takes and return to the Home Screen.

4. Press .

5. Use  to select "Select", and press .

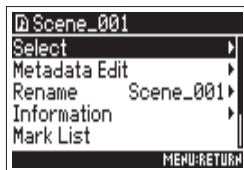

6. Use  to select "Yes", and press .

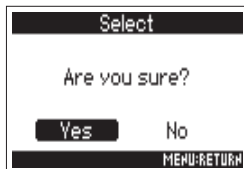

NOTE

The first take inside the selected SD card or folder will be set as the playback take.

Changing folder and take names

4. Press .

5. Use  to select Rename, and press .

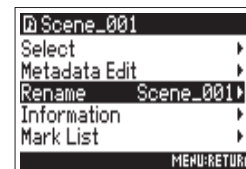

6. Change the folder or take name.

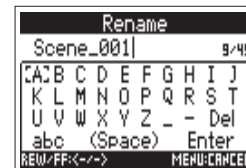

See "Character input screen" (→ P.13) for how to input characters.

NOTE

- The edited name of the folder/take is written to the <PROJECT> or <SCENE> metadata.
- You cannot put a space or an @ mark at the beginning of the name.

Checking take information

4. Press .

5. Use  to select Information, and press .

Use  to scroll the screen and show information that is hidden.

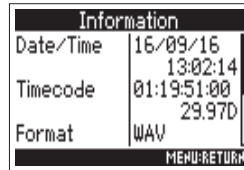
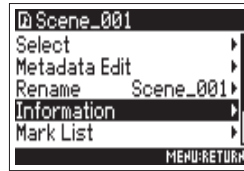

| Item | Explanation |
|--------------|-------------------------|
| Date/Time | Date and time created |
| Timecode | Timecode |
| Format | Recording format |
| Length | Length of time |
| Size | Size |
| SideMicLevel | Mid-side side mic level |

Checking take marks and using them for playback

You can view a list of the marks in a recorded take.

4. Press .

5. Use  to select Mark List, and press .

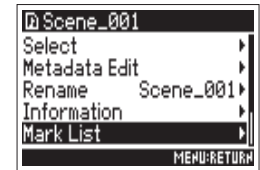

6. Use  to select a mark, and press .

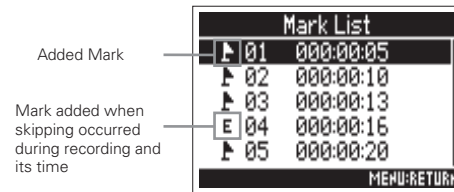

7. Use  to select "Yes", and press .

The Home Screen will reopen, and playback will start from the mark.



Take and folder operations (Finder) (continued)

Copying takes to other cards and folders

4. Press .

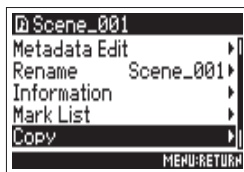

5. Use  to select Copy, and press .

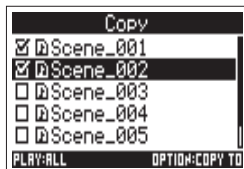

6. Use  to select the take to copy, and press .



7. Press .

8. Use  to select the copy destination, and press .

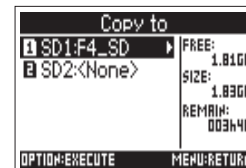

NOTE

- See "Take and folder operations" for how to select a folder. (→ P.52)

9. Use  to select "Yes", and press .

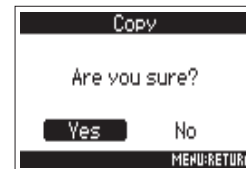



Deleting folders and takes

4. Press .

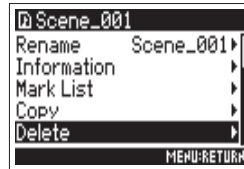
5. Use  to select Delete, and press .



6. Use  to select the folder/take to delete, and press . Press  to cancel deletion.

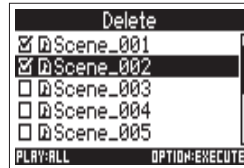

NOTE

You can press  to select/deselect all the folders and takes that are currently shown.

7. Press .

8. Use  to select "Yes", and press .



NOTE

- Deleted folders and takes are not immediately erased from the SD card. They are moved to the TRASH folder.
- Deleting the folders and takes in the TRASH folder will completely erase their data.

Take and folder operations (Finder) (continued)

Emptying the TRASH/FALSE TAKE folder

4. Use  to select TRASH or FALSE TAKE.

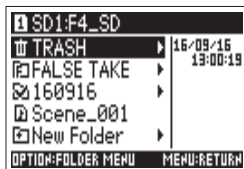

TRASH folder

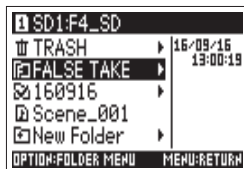

FALSE TAKE folder

5. Press .

6. Use  to select Empty, and press .



TRASH folder



FALSE TAKE folder

7. Use  to select "Yes", and press .



NOTE

- Emptying the TRASH folder will completely erase the data in it.
- Emptying the FALSE TAKE folder does not immediately erase its data from the SD card. The data is moved to the TRASH folder.

Overview of take metadata stored in files

The **F4** writes a variety of information (metadata) to files during recording.

When these files are read by an application that supports metadata, you should be able to check and use the saved information.

HINT

- Metadata is data that contains information related to other data. The **F4** saves scene names and take numbers, for example, as metadata in audio files.
- A chunk is a unit that contains multiple data in a single block.
- To use BEXT and iXML chunk metadata, an application that supports both data formats is necessary.

WAV file metadata

The metadata saved in files recorded by the **F4** in WAV format is collected in BEXT (Broadcast Audio Extension) and iXML chunks.

For details about the metadata saved in these chunks, see "Metadata contained in BEXT chunks in WAV files" (→ P.152), "Metadata contained in iXML chunks in WAV files" (→ P.153).

MP3 file metadata

The metadata saved in files recorded by the **F4** in MP3 format is written as ID3v1 tags.

For information about the ID3 fields and formats saved as metadata, see "Metadata and ID3 fields contained in MP3 files" (→ P.155).

HINT

- **F4** MP3 files conform to the MPEG-1 Layer III standard.
- MP3 metadata cannot be edited.

Checking and editing take metadata (Metadata Edit)

1. Press .

2. Use  to select **FINDER**,
and press .

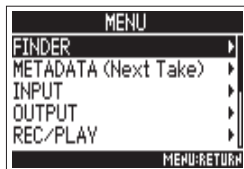

3. Use  to select the take,
and press .

This opens the Option Screen.
See "Take and folder operations"
for how to use the Finder. (→ P.52)

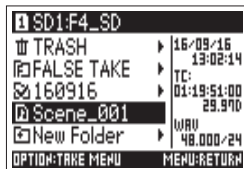

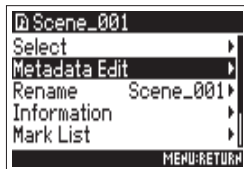

4. Use  to select **Metadata**
Edit, and press .



► Continue to one of the following procedures.

| | |
|--|------|
| Checking and editing notes..... | P.61 |
| Selecting notes from the history list | P.61 |
| Checking and editing scene names..... | P.62 |
| Selecting a scene name from the history list | P.62 |
| Checking and editing take names | P.63 |
| Circling takes..... | P.63 |
| Changing folder (tape) names | P.64 |
| Changing project names | P.64 |
| Checking and changing track names..... | P.65 |
| Selecting a track name from the History list | P.66 |

Checking and editing notes

5. Use  to select Note, and press .

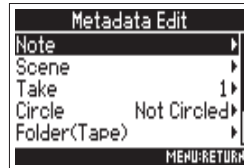

6. Use  to select Edit, and press .



7. Edit the note.

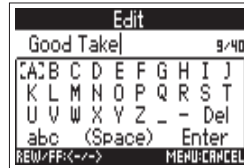

See "Character input screen" (→ P.13) for how to input characters.



NOTE

The contents of this note is written to the <NOTE> metadata.

Selecting notes from the history list

5. Use  to select Note, and press .

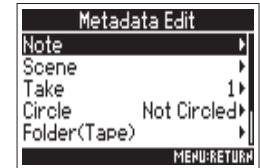

6. Use  to select History, and press .

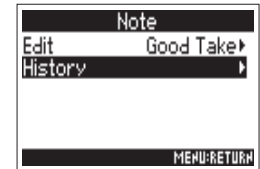

7. Use  to select the History item to use, and press .



NOTE

The history list will be erased if the Factory Reset function is used.

Checking and editing take metadata (Metadata Edit) (continued)

Checking and editing scene names

5. Use  to select Scene, and press .

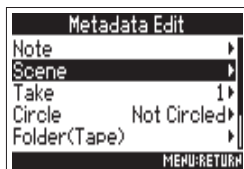

6. Use  to select Edit, and press .

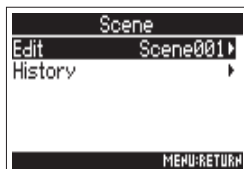

7. Editing scene names

See "Character input screen" (→ P.13) for how to input characters.



NOTE

The scene name is written to the <SCENE> metadata.

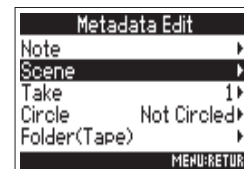

Selecting a scene name from the history list

5. Use  to select Scene, and press .



6. Use  to select History, and press .



7. Use  to select the History item to use, and press .



NOTE

The history list will be erased if the Factory Reset function is used.

Checking and editing take names

5. Use  to select Take, and press .

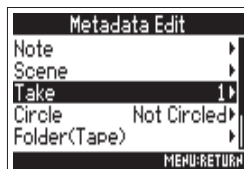

6. Changing the take number

- Editing operations

Move cursor or change value:



Select parameter to change:





HINT

This can be set from 1 to 999.

NOTE

The take number is written to the <TAKE> metadata.

7. When done editing, use  to select Enter, and press .



Circling takes

Use this function to add an @ mark to the beginning of the name of the best take to make it stand out. This is called a "circled take".

5. Use  to select Circle, and press .

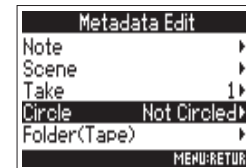

6. Use  to select Circled, and press .

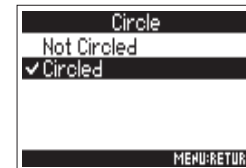

NOTE

- To clear a circle, select Not Circled and press .
- This circled status is written to the <CIRCLE> metadata.

Checking and editing take metadata (Metadata Edit) (continued)

Changing folder (tape) names

5. Use  to select Folder (Tape) and press .

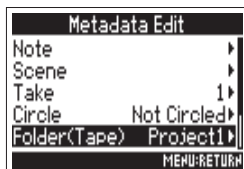

6. Edit the folder (tape) name.

See "Character input screen" (→ P.13) for how to input characters.

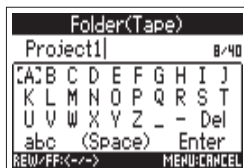

NOTE

- The folder (tape) name is written to the <TAPE> metadata.
- The folder (tape) name used immediately after recording is the name of the folder in which the take was recorded.

Changing project names

5. Use  to select Project, and press .



6. Change the project name.

See "Character input screen" (→ P.13) for how to input characters.

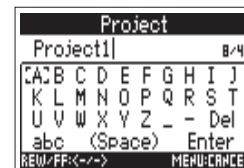

NOTE

- The project name is written to the <PROJECT> metadata.
- The project name used immediately after recording is the name of the highest level folder (inside the SD card root directory) that contains the folder in which the take was recorded.

Checking and changing track names

5. Use  to select Track Name, and press .

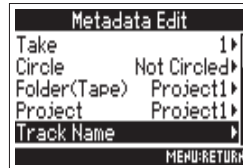

6. Use  to select the track, and press .

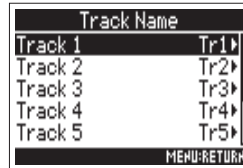

7. Use  to select Edit, and press .



8. **Editing the track name**

See "Character input screen" (→ P.13) for how to input characters.

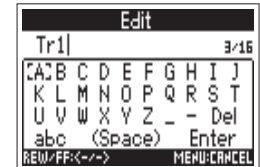

NOTE

The track name is written to the <TRACK> <NAME> metadata.

Checking and editing take metadata (Metadata Edit) (continued)

Selecting a track name from the history list

5. Use  to select Track Name, and press .



| Metadata Edit | |
|---------------|--------------|
| Take | 1▶ |
| Circle | Not Circled▶ |
| Folder(Tape) | Project1▶ |
| Project | Project1▶ |
| Track Name | ▶ |
| MENU:RETURN | |

6. Use  to select the track, and press .

| Track Name | |
|-------------|------|
| Track 1 | Tr1▶ |
| Track 2 | Tr2▶ |
| Track 3 | Tr3▶ |
| Track 4 | Tr4▶ |
| Track 5 | Tr5▶ |
| MENU:RETURN | |

7. Use  to select History, and press .

| Track 1 | |
|-------------|------|
| Edit | Tr1▶ |
| History | ▶ |
| MENU:RETURN | |

8. Use  to select the History item to use, and press .

| History | |
|-------------|--|
| Boom | |
| Mic | |
| Line | |
| Wireless | |
| Mix | |
| MENU:RETURN | |

NOTE

The history list will be erased if the Factory Reset function is used.



Writing a sound report (Create Sound Report)

A sound report includes information about recording times and takes.
Reports can be written as CSV format files (F4_[folder name].CSV).
You can edit comments written in sound reports.

1. Press .

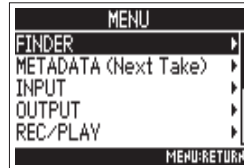
2. Use  to select FINDER,
and press .



3. Use  to select the folder
or SD card for which you
want to create a sound
report, and press .

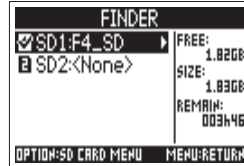

4. Use  to select Create
Sound Report, and press .



► Continue to one of the following procedures.

| | |
|--|------|
| Writing sound reports | P.68 |
| Editing comments..... | P.68 |
| Selecting comments from the history list | P.69 |

Writing a sound report (Create Sound Report) (continued)

Writing sound reports

5. Use  to select Create, and press .



6. Use  to select "Yes", and press .

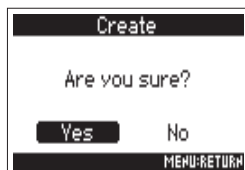

This writes the sound report inside the selected SD card or folder.

NOTE

- Only information about takes in the folder or SD card is written in the sound report.
- If a sound report file with the same name already exists, it will be overwritten. Please use caution.

Editing comments

5. Use  to select Info Edit, and press .



6. Use  to select Comments, and press .



7. Use  to select Edit, and press .



8. **Editing comments**

See "Character input screen" (→ P.13) for how to input characters.

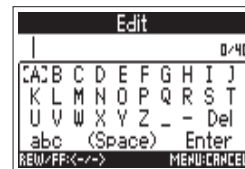

Selecting comments from the history list

5. Use  to select Info Edit,
and press .





6. Use  to select Comments,
and press .



7. Use  to select History,
and press .



8. Use  to select the History
item to use, and press .

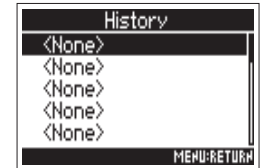

HINT

The history list will be erased if the Factory Reset function is used.

Input and output signal flow

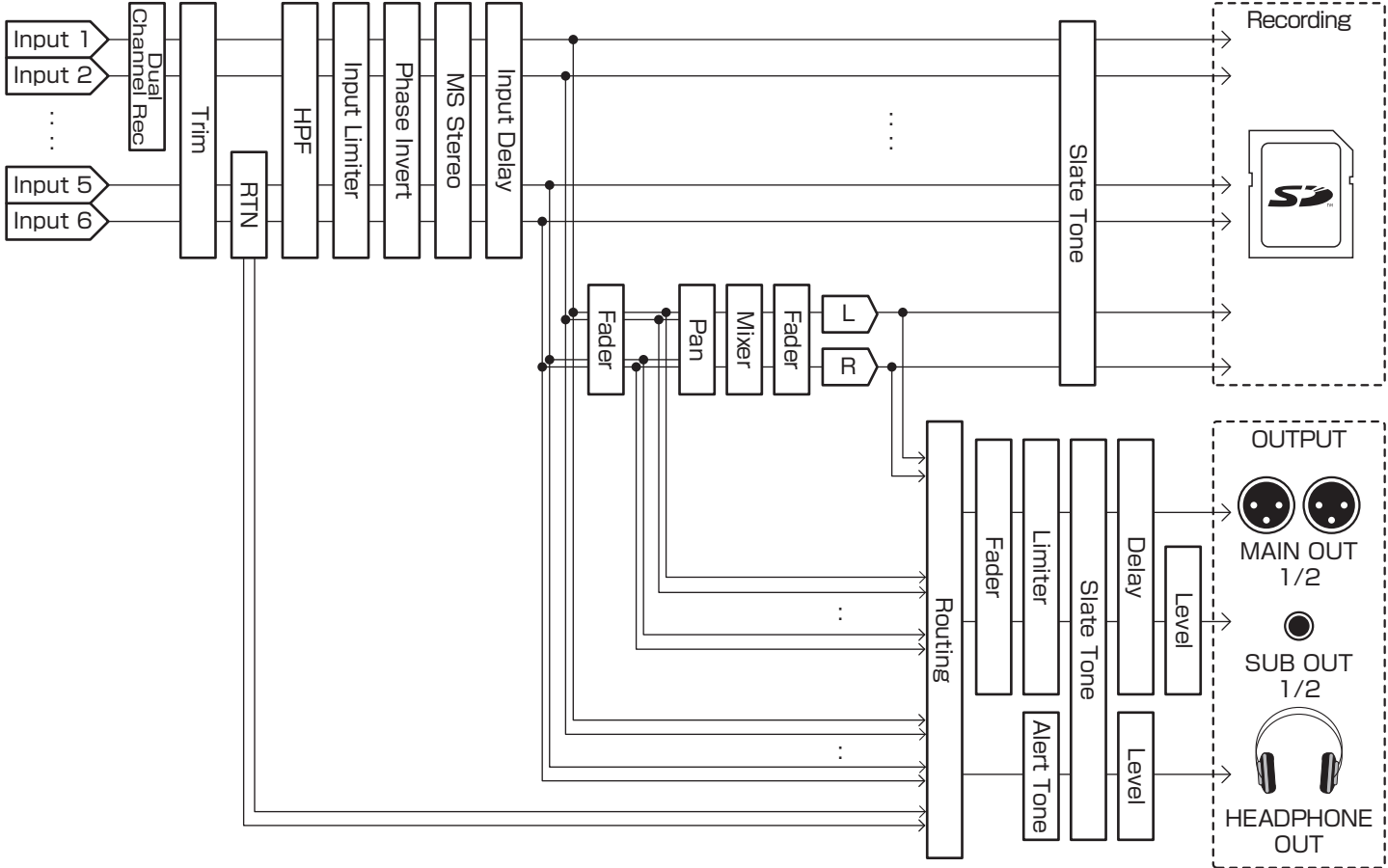

Adjusting the L/R track volume

1. Open the Home Screen.

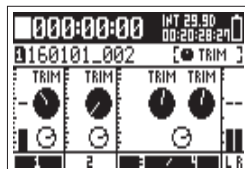

2. Press **OPTION** + **PFL** (Track 3).

NOTE

Shortcuts are disabled during playback.

3. Use  to adjust the volume.

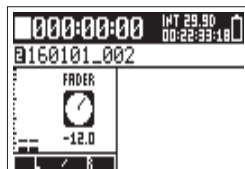

NOTE

- Volume settings affect the results of recording.
- If only the L/R track is recorded, the L/R track fader setting for the take will be saved as 0 dB.

4. When finished adjusting, press **MENU**.

Monitoring the input signals of specified tracks (PFL/SOLO)

You can monitor the input signals of specified tracks. You can also make various settings for selected tracks.

1. Press **PFL**  or **INPUT 5/6**  for the tracks that you want to monitor.

The selected track keys will light orange, and the PFL screen will open.

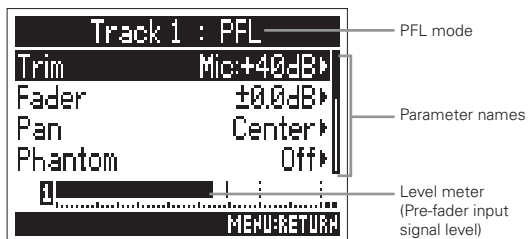

"PFL" or "SOLO" appears at the top of the display, and you will be able to monitor the input signal with headphones.



| Parameter | Explanation |
|----------------|---|
| Input | Turns input On/Off |
| Level | Sets standard input level for RTN (INPUT 5/6) |
| Trim | Sets input level |
| Fader | Sets fader level |
| Pan | Sets panning |
| Phantom | Sets phantom power supply |
| HPF | Sets high pass filter |
| Input Limiter | Sets limiter |
| Phase Invert | Sets polarity |
| Side Mic Level | Sets side mic level of mid-side capsule |
| Input Delay | Sets input delay |
| Plugin Power | Sets plugin power |
| Stereo Link | Sets stereo link |
| PFL Mode | Sets monitoring volume on the PFL screen |

HINT

- Use  to select parameters and change setting values.
- During playback, you can monitor the playback signals of selected tracks.

2. Press **PFL**  for the selected track, **INPUT 5/6**  or **MENU** .

Setting the monitoring volume on the PFL screen (PFL Mode)

On the PFL screen, you can set the monitoring sound to be either pre-fader listening (PFL) or post-fader solo (SOLO).

1. Press .

2. Use  to select INPUT,
and press .

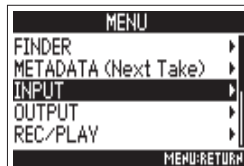

3. Use  to select PFL Mode,
and press .

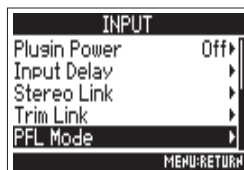

4. Use  to select the track,
and press .

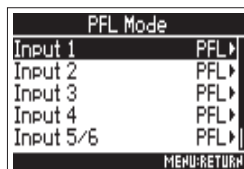

5. Use  to select the setting,
and press .

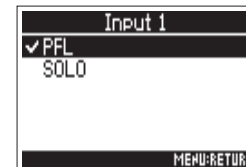

| Setting value | Explanation |
|---------------|--|
| PFL | On the PFL screen, monitor the pre-fader sound. |
| SOLO | On the PFL screen, monitor the post-fader sound. |

NOTE

When the PFL screen is open during playback, the monitoring sound will be post-fader (SOLO) regardless of the setting.

HINT

Select All to set all the tracks at the same time.

Cutting low-frequency noise (HPF)

The high pass filter can cut low frequencies to reduce the sound of wind, vocal pops and other noise.

1. Press .

2. Use  to select INPUT,
and press .

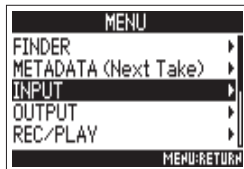

3. Use  to select HPF,
and press .

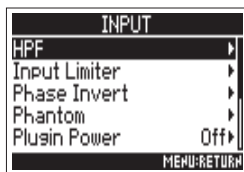

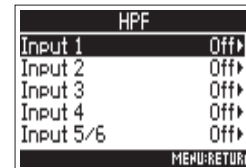

4. Use  to select the track,
and press .



HINT

Select All to set all the tracks at the same time.

5. Use  to set the cutoff
frequency, and press .



NOTE

The HPF also affects dual channel recording data.

HINT

This can be set to Off or between 80 and 240 Hz.

Input limiter

The limiter can prevent distortion by controlling input signals that have excessively high levels.

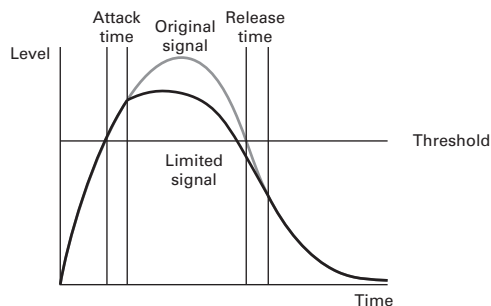

When the limiter is ON, if the input signal level exceeds the set threshold value, the signal level will be suppressed to prevent the sound from distorting.

The attack time is how long after the signal exceeds the threshold until the limiter starts operating. The release time is how long after the signal goes below the threshold until the limiter stops operating. Change these two parameters to adjust the sound quality.

HINT

- The **F4** uses a newly-designed limiter. This limiter has 10dB of headroom, preventing distortion and allowing it to keep signals below the set threshold even more than ordinary limiters.
- The ratio of the **F4** limiter is 20:1.

1. Press .

2. Use  to select INPUT, and press .

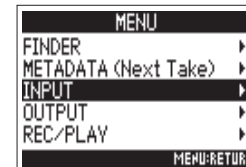

3. Use  to select Input Limiter, and press .

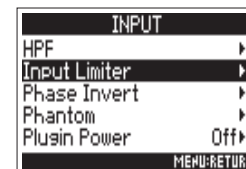

4. Use  to select the track, and press .

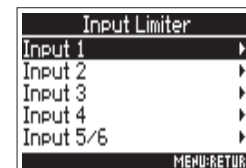

HINT

Select All to set all the tracks at the same time.

Input limiter (continued)

- Continue to one of the following procedures.

| | |
|--------------------------------|------|
| Using the limiter | P.76 |
| Setting the type | P.76 |
| Setting the threshold | P.77 |
| Setting the attack time | P.77 |
| Setting the release time | P.78 |

Using the limiter

- 5.** Use  to select On/Off, and press .

| Input 1 | |
|--------------|------------|
| On/Off | Off▶ |
| Type | Hard Knee▶ |
| Threshold | - 2dBFS▶ |
| Attack Time | 1ms▶ |
| Release Time | 200ms▶ |
| MENU-RETURN | |

- 6.** Use  to select On, and press .

| On/Off | |
|-------------|--|
| Off | |
| ✓ On | |
| MENU-RETURN | |

Setting the type

- 5.** Use  to select Type, and press .

| Input 1 | |
|--------------|------------|
| On/Off | Off▶ |
| Type | Hard Knee▶ |
| Threshold | - 2dBFS▶ |
| Attack Time | 1ms▶ |
| Release Time | 200ms▶ |
| MENU-RETURN | |

- 6.** Use  to select the type, and press .

| Type | |
|-------------|--|
| ✓ Hard Knee | |
| Soft Knee | |
| MENU-RETURN | |

| Setting value | Explanation |
|---------------|---|
| Hard Knee | Only peaks that exceed the threshold are attenuated. There is no effect below the threshold. |
| Soft Knee | The limiter gradually affects the signal about 6 dB below the threshold for a gentler effect. |

Setting the threshold

This sets the base level from which the limiter operates.

- 5.** Use  to select Threshold and press .

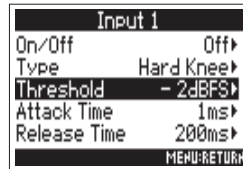

- 6.** Use  to adjust the setting, and press .

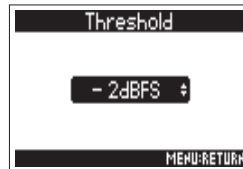

HINT

This can be set from -16 to -2 dBFS.

Setting the attack time

This sets the amount of time until compression starts after the input signal exceeds the threshold.

- 5.** Use  to select Attack Time, and press .

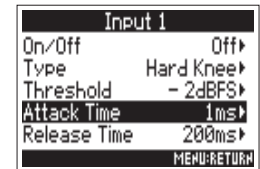

- 6.** Use  to adjust the time, and press .





HINT

This can be set from 1 to 4 ms.

Input limiter (continued)

Setting the release time

This sets the amount of time until compression stops after the input signal goes below the threshold.

- 5.** Use  to select Release Time, and press .



- 6.** Use  to adjust the time, and press .



HINT

This can be set from 1 to 500 ms.

NOTE

- Limiter operation is linked for tracks that have stereo link or MS stereo link enabled. If the signal for either linked channel reaches the threshold, the limiter will operate on both tracks.
- When the limiter is operating, the end of the level meter and the mixer limiter indicator light on the display.

Inverting the input phase (Phase Invert)

The phase of the input signal can be inverted.

This is useful when sounds cancel each other out due to mic settings.

1. Press .

2. Use  to select INPUT,
and press .

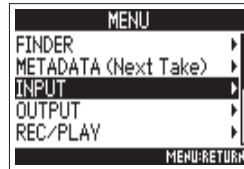

3. Use  to select Phase
Invert, and press .

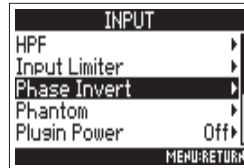

4. Use  to select the track,
and press .

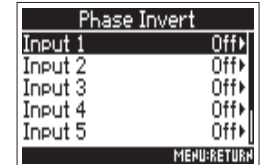

HINT

Select All to set all the tracks at the same time.

5. Use  to select On, and
press .

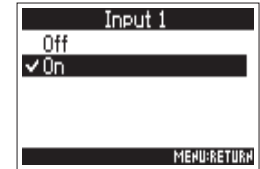

Changing the phantom power settings (Phantom)

The **F4** can provide phantom power. The voltage can be set to +24V or +48V and it can be turned on/off for each input separately.

HINT

Phantom power is a function that supplies power to devices that require an external power supply, including some condenser mics. The standard power is +48V, but some devices can operate with lower voltages.

NOTE

Do not use this function with devices that are not compatible with phantom power. Doing so could damage the device.

1. Press .

2. Use  to select INPUT, and press .

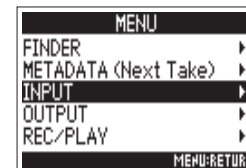

3. Use  to select Phantom, and press .

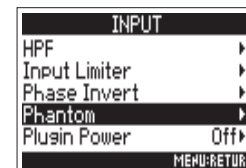

► Continue to one of the following procedures.

Using phantom power P.81

Setting the voltage..... P.81

Disabling phantom power during playback P.82

Using phantom power

4. Use  to select On/Off, and press .

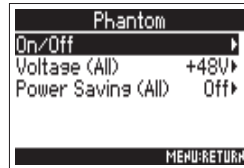

5. Use  to select the track, and press .

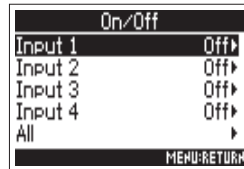
**HINT**

Select All to set all the tracks at the same time.

6. Use  to select On, and press .

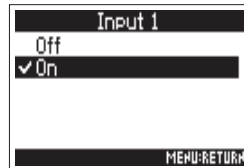

Setting the voltage

4. Use  to select Voltage (All), and press .

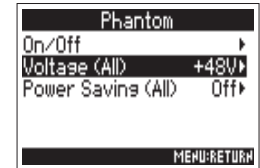

5. Use  to select the voltage, and press .

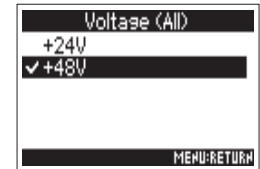
**NOTE**



This setting affects all tracks.

HINT

When using mics and other equipment that can operate with voltages less than +48V, selecting the lower voltage can reduce the **F4** power consumption.

Changing the phantom power settings (Phantom) (continued)

Disabling phantom power during playback

4. Use  to select Power Saving (All), and press .



5. Use  to select On, and press .



| Setting value | Explanation |
|----------------------|---|
| Off | Phantom power is supplied even during playback. |
| On (During playback) | Phantom power is not supplied during playback. This can reduce the F4 power consumption. |

NOTE

This setting affects all tracks.

HINT

If supplying phantom power to mics is not necessary during playback, disabling it then can reduce **F4** power consumption.



Changing the plugin power setting (Plugin Power)

Make this setting when a mic that is compatible with plug-in power is connected to the mic capsule [MIC/LINE] input jack.

1. Press .

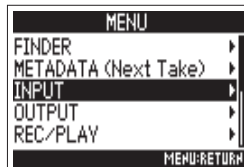
2. Use  to select INPUT,
and press .



3. Use  to select Plugin
Power, and press .

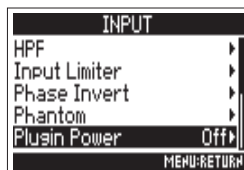

4. Use  to select On,
and press .

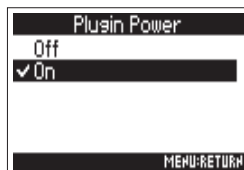



Applying delay to input signals (Input Delay)

If there are differences in the timing of input sounds, use this function to correct them when recording.

1. Press .

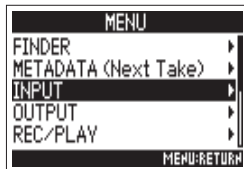
2. Use  to select INPUT, and press .



3. Use  to select Input Delay, and press .

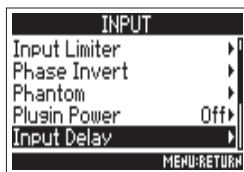

4. Use  to select the track, and press .

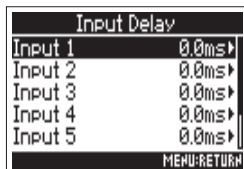

HINT

Select All to set all the tracks at the same time.

5. Use  to adjust the delay time, and press .



HINT

This can be set from 0 to 30.0 ms.

NOTE

When Sample Rate is set to 192kHz, Input Delay is disabled.

Converting mid-side input to stereo (Stereo Link Mode)

Signals from a mid-side format stereo mic input through stereo-linked tracks are converted to an ordinary stereo signal. See "Linking inputs as a stereo pair" (→ P.26) for how to use stereo linking.

MS stereo format overview

This technique converts to stereo signals input from a directional mid mic that captures sound in the center and a bidirectional side mic that captures sounds from the left and right.

You can change the stereo width as you like by adjusting the side mic level.

Since this technique can capture a wide stereo image, it is ideal for recording wide open spaces with numerous sound sources, including orchestras, live concerts and soundscapes.

This technique is also extremely effective when you want to adjust room ambience. Since it offers a high degree of freedom, it is used not only in studios but also for a wide range of recording—even of rehearsals and live performances.

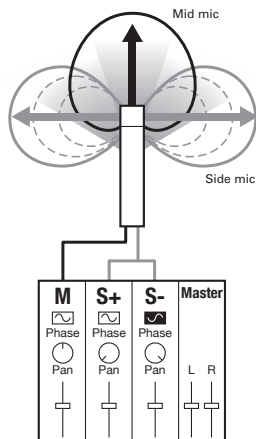

1. Press .

2. Use  to select INPUT, and press .

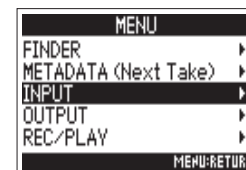

3. Use  to select Stereo Link, and press .

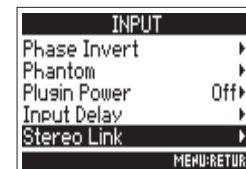

4. Use  to select the track, and press .

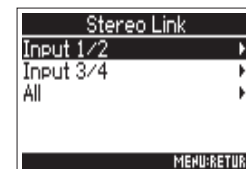

HINT

Select All to set all the tracks at the same time.

Converting mid-side input to stereo (Stereo Link Mode) (continued)

5. Use  to select Mode, and press .

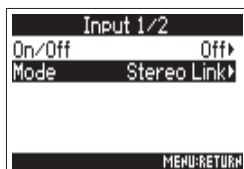

6. Use  to select MS Stereo Link, and press .

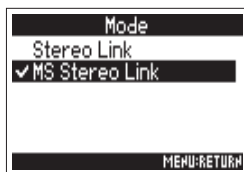

| Setting value | Explanation |
|----------------|---|
| Stereo Link | When stereo-linked, inputs are handled normally. |
| MS Stereo Link | When stereo-linked, signals from a mid-side mic are converted to ordinary stereo. |

NOTE

- When MS Stereo Link is selected, odd tracks are handled as mid signals and even tracks as side signals.

HINT

- Use  for each track to adjust the mid/side balance.
- You can adjust the side mic level for tracks that have a mid-side mic capsule connected on the PFL screen.

Adjusting multiple track input levels together (Trim Link)

The input levels of multiple tracks can be linked and adjusted at the same time.

1. Press .

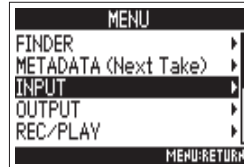

2. Use  to select INPUT, and press .



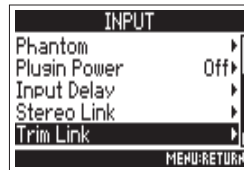

3. Use  to select Trim Link, and press .



HINT

You can also open the Trim Link screen from the Home Screen by pressing  while pressing and holding .

4. Use  to select a track to link, and press .

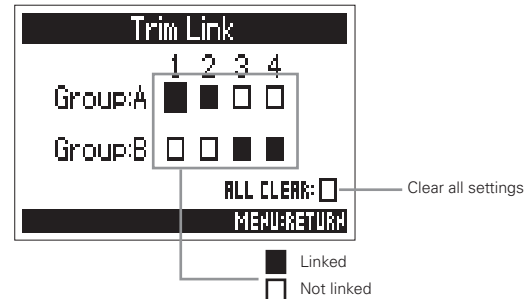

HINT

- You can use  for the first track in a link group to adjust all the input levels within that group at the same time.
- Icons for group names are shown next to linked tracks.

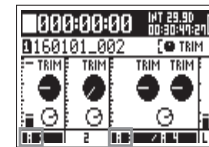

NOTE

- A track cannot be in more than one group at a time.
- The input levels of tracks set to MS Stereo Link will also be linked if those tracks are put into groups.

Using Input 5/6 as a return (RTN) input

Input 5/6 can be used as a return (RTN) input.

By inputting audio output from a camera through the RTN (INPUT 5/6) jack, you can monitor this signal through headphones without recording it.

1. Press .

2. Use  to select INPUT, and press .

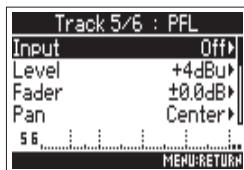

3. Use  to select RTN (Monitor Only), and press .

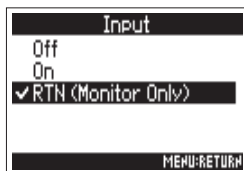



NOTE

- When Input 5/6 set to RTN, Tracks 5/6 will not be recorded.
- When a mic capsule is connected, RTN (Monitor Only) cannot be selected.
- If you want the RTN signal to always be output, change the routing settings as necessary.
- When this setting is RTN (Monitor Only), Fader, Pan, HPF, Input Limiter, Phase Invert and Input Delay are disabled.



Adjusting the side mic level of a mid-side mic capsule (Side Mic Level)

You can adjust the side mic level (stereo width) before recording for tracks that use a mid-side mic capsule

1. Press .

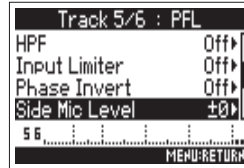
2. Use  to select Side Mic Level, and press .



3. Use  to adjust the side mic level, and press .



HINT

This can be set to Off, RAW or in a range from -24 to +6 dB.

NOTE

- The more the side mic level is increased, the greater the stereo width becomes.
- When set to RAW, recording will occur without stereo encoding. The stereo width of audio in RAW format can be adjusted after recording by using ZOOM MS Decoder or other plug-in software.

Setting signals sent to the output jacks (Routing)

You can set the type of signal sent to the headphone output, MAIN OUT and SUB OUT to either prefader or postfader for each track.

1. Press **MENU**.

2. Use  to select **OUTPUT**, and press .

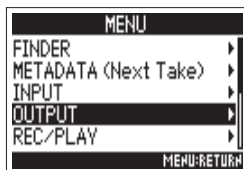

3. Use  to select **Routing**, and press .

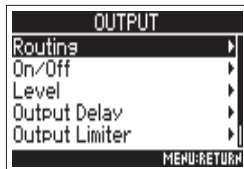



▶ Continue to one of the following procedures.

| | |
|--|------|
| Setting signals sent to the headphone output | P.90 |
| Setting signals sent to the MAIN OUT | P.92 |
| Setting signals sent to the SUB OUT | P.93 |

Setting signals sent to the headphone output

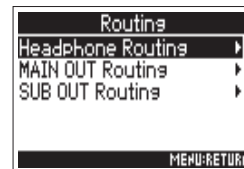
4. Use  to select **Headphone Routing**, and press .



5. Use  to select the tracks/outputs for routing, and press .

Headphone Routing

| | | | | | | | | | | | |
|-------------------------------------|-------------------------------------|-------------------------------------|-------------------------------------|-------------------------------------|-------------------------------------|-------------------------------------|-------------------------------------|-------------------------------------|-------------------------------------|-------------------------------------|-------------------------------------|
| 1 | 2 | 3 | 4 | 5 | 6 | L | R | M1 | 2 | S1 | 2 |
| <input checked="" type="checkbox"/> | <input checked="" type="checkbox"/> | <input checked="" type="checkbox"/> | <input checked="" type="checkbox"/> | <input checked="" type="checkbox"/> | <input checked="" type="checkbox"/> | <input checked="" type="checkbox"/> | <input checked="" type="checkbox"/> | <input checked="" type="checkbox"/> | <input checked="" type="checkbox"/> | <input checked="" type="checkbox"/> | <input checked="" type="checkbox"/> |
| <input checked="" type="checkbox"/> | <input checked="" type="checkbox"/> | <input checked="" type="checkbox"/> | <input checked="" type="checkbox"/> | <input checked="" type="checkbox"/> | <input checked="" type="checkbox"/> | <input checked="" type="checkbox"/> | <input checked="" type="checkbox"/> | <input checked="" type="checkbox"/> | <input checked="" type="checkbox"/> | <input checked="" type="checkbox"/> | <input checked="" type="checkbox"/> |

MS: MS: MS: MONO MIX:

PRE: POST: ALL CLEAR:

MENU-RETURN

- Prefader selected
- Postfader selected
- Off
- Tracks routed to the left headphone channel
- Tracks routed to the right headphone channel
- Mono mix
- Clear all settings

Mid-side stereo monitoring

- Press to cycle through settings
- Change tracks 1-6 to postfader (cancel others)
 - Change L/R to postfader (cancel others)
 - Change M1/M2 to postfader (cancel others)
 - Change S1/S2 to postfader (cancel others) (cancel MS)



Press to set tracks 1-6 to prefader (cancel MS)

NOTE



- You cannot set L/R, MAIN OUT 1/2 or SUB OUT 1/2 to prefader.
- You cannot select the 1–6, L/R , MAIN OUT 1/2 and SUB OUT 1/2 tracks at the same time. Selecting one will deselect any other.

HINT

Press  to cycle through the options:
 Prefader → Postfader → Off.

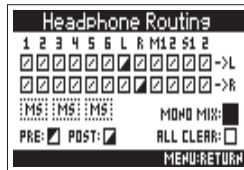
6. To make the headphone output mono, use  to select MONO MIX, and press .



7. To monitor a mid-side stereo signal, use  to select MS, and press .

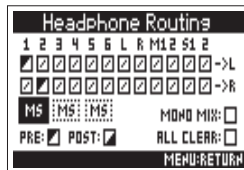

NOTE

- Mid-side stereo monitoring is disabled for stereo-linked tracks that have Stereo Link Mode set to MS Stereo Link.
- When mid-side stereo monitoring is enabled, the prefader tracks will be routed automatically to the headphone channels, with odd to the left and even to the right. In this case, the routing cannot be changed manually.



HINT

Signals from a mid-side stereo mic can be converted to an ordinary stereo signal for monitoring (MS stereo monitoring).

8. Press .

Setting signals sent to the output jacks (Routing) (continued)

Setting signals sent to the MAIN OUT

4. Use  to select MAIN OUT Routing, and press .

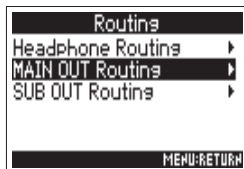

5. Use  to select the track for MAIN OUT 1 or MAIN OUT 2 routing and press .

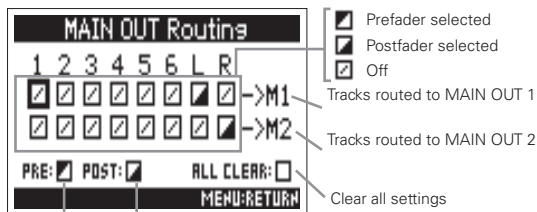

- Press to cycle through settings
- Change tracks 1–6 to postfader (cancel others)
 - Change L/R tracks to postfader (cancel others)

Press to set tracks 1–6 to prefader

HINT



Press  to cycle through the options:
Prefader → Postfader → Off.

NOTE

- Tracks 1–6 can be set to Prefader or Postfader.
- The L/R tracks can only be set to Postfader.
- Tracks 1–6 and L/R tracks cannot be selected at the same time. Selecting one type will deselect the other.

6. Press .

Setting signals sent to the SUB OUT

4. Use  to select SUB OUT Routing, and press .

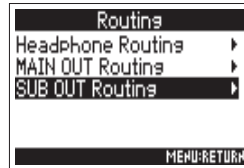

NOTE

- Tracks 1–6 can be set to Prefader or Postfader.
- The L/R tracks can only be set to Postfader.
- Tracks 1–6 and L/R tracks cannot be selected at the same time. Selecting one type will deselect the other.

5. Use  to select the track for SUB OUT 1 or SUB OUT 2 routing and press .

6. Press .

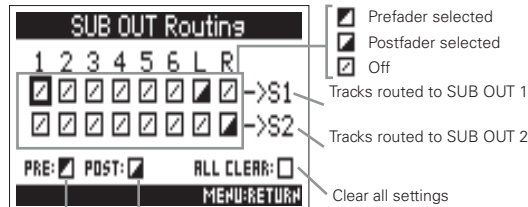

- Press to cycle through settings
- Change tracks 1–6 to postfader (cancel others)
 - Change L/R tracks to postfader (cancel others)

Press again to set tracks 1–6 to prefader

HINT

Press  to cycle through the options:
 Prefader → Postfader → Off.

Disabling outputs (Output On/Off)

Disabling unused outputs can reduce power consumption, increasing the length of continuous operation using batteries.

1. Press .

2. Use  to select OUTPUT,
and press .

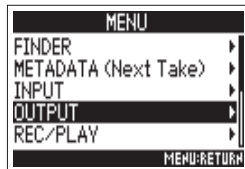

3. Use  to select On/Off,
and press .

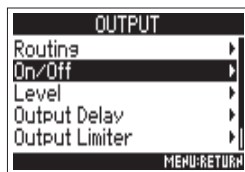

4. Use  to select the output
and press .

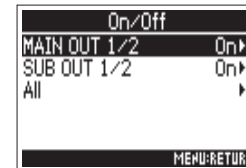

HINT

Select All to set all the outputs at the same time.

5. Use  to select Off,
and press .

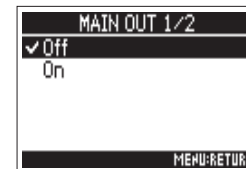

Setting the standard output level (Output Level)

The standard output level can be changed.

1. Press .

2. Use  to select OUTPUT, and press .

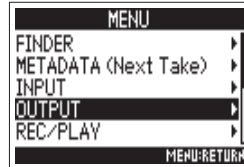

3. Use  to select Level, and press .

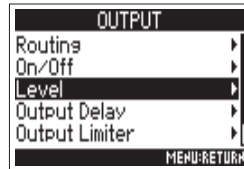

4. Use  to select the output and press .

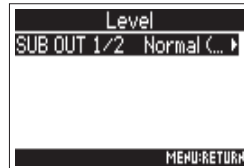

5. Use  to set the standard output level, and press .

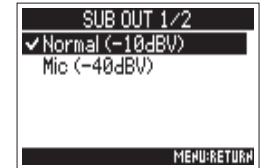

| Setting value | Explanation |
|-----------------|--|
| Normal (-10dBV) | This sets the standard level to -10 dBV. |
| Mic (-40dBV) | This sets the standard level to -40 dBV. |

Setting the output level

The MAIN OUT 1/2 and SUB OUT 1/2 levels can be changed.

1. Open the mixer on the Home Screen. (→ P.11)

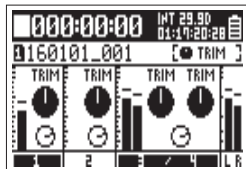

2. Press .

3. Use  to select Fader, and press .

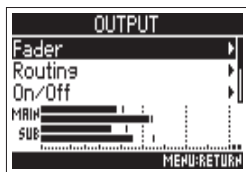

4. Use  to select the output, and press .

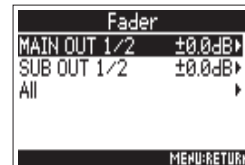

HINT

Select All to set all the outputs at the same time.

5. Use  to adjust the output level, and press .

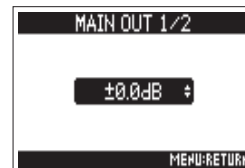

HINT

This can be set to Mute or from -48.0 to +12.0 dB.



Applying delay to the output (Output Delay)

By delaying output, you can correct timing differences for audio input into another device.

1. Press .

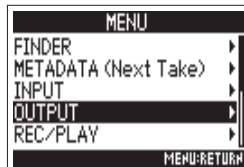
2. Use  to select OUTPUT, and press .



3. Use  to select Output Delay, and press .

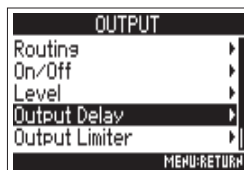

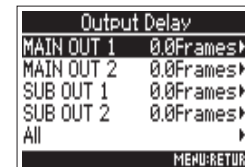

4. Use  to select the output, and press .



HINT

Select All to set all the outputs at the same time.

5. Use  to adjust the delay in frames, and press .

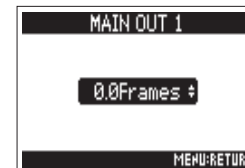

HINT

This can be set from 0.0 to 10.0 frames.

NOTE

- Delays set in frames differ according to the frame rate of the selected timecode.
- When Sample Rate is set to 192kHz, Output Delay is disabled.

Output Limiter

Using a limiter on the output can protect devices connected to the output jacks.



HINT

For details about the limiter, see "Input limiter". (→ P.75)

1. Press .

2. Use  to select OUTPUT,
and press .



3. Use  to select Output
Limiter, and press .

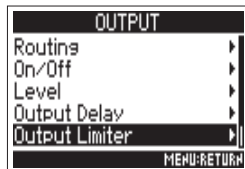

4. Use  to select the track,
and press .

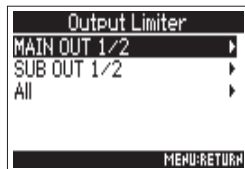

HINT

Select All to set all the outputs at the same time.

► Continue to one of the following procedures.

| | |
|--------------------------------|-------|
| Using the limiter | P.98 |
| Setting the type..... | P.99 |
| Setting the threshold..... | P.99 |
| Setting the attack time..... | P.100 |
| Setting the release time | P.100 |
| Linking the limiter..... | P.101 |

Using the limiter

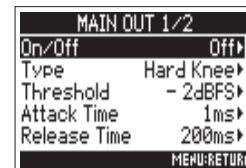

5. Use  to select On/Off,
and press .

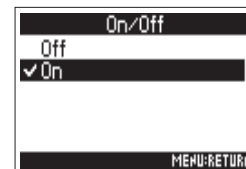

6. Use  to select On,
and press .



Setting the type

5. Use  to select Type, and press .

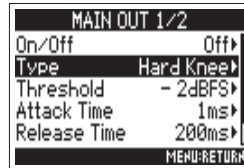

6. Use  to select the type, and press .



| Setting value | Explanation |
|---------------|---|
| Hard Knee | Only peaks that exceed the threshold are attenuated. There is no effect below the threshold. |
| Soft Knee | The limiter gradually affects the signal about 6 dB below the threshold for a gentler effect. |

Setting the threshold

This sets the base level from which the limiter operates.

5. Use  to select Threshold, and press .

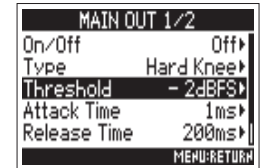

6. Use  to adjust the setting, and press .





HINT

This can be set from -16 to -2 dBFS.

Output Limiter (continued)

Setting the attack time

This sets the amount of time until compression starts after the input signal exceeds the threshold.

5. Use  to select Attack Time, and press .

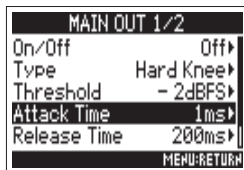

6. Use  to adjust the time, and press .





HINT

This can be set from 1 to 4 ms.

Setting the release time

This sets the amount of time until compression stops after the input signal goes below the threshold.

5. Use  to select Release Time, and press .

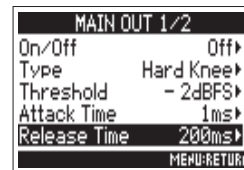

6. Use  to adjust the time, and press .





HINT

This can be set from 1 to 500 ms.

Linking the limiter

The limiter can be linked or applied independently to MAIN OUT 1 and 2, as well as to SUB OUT 1 and 2.

- 5.** Use  to select Link,
and press .

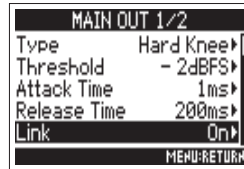

- 6.** Use  to select On,
and press .

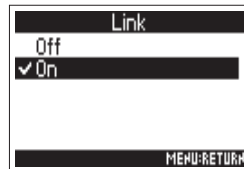

| Setting value | Explanation |
|---------------|--|
| Off | Separate limiter operation. |
| On | Link limiter operation. If the signal for either linked signal reaches the threshold, the limiter will operate on both channels. |



Outputting alerts through headphones (Alert Tone Level)

The volume can be adjusted for alerts output from headphones when, for example, recording starts and stops.

1. Press .

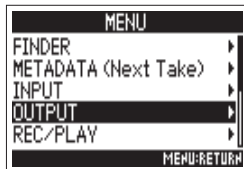
2. Use  to select OUTPUT, and press .



3. Use  to select HP Alert Tone Lvl, and press .

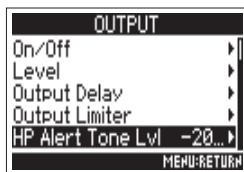

4. Use  to adjust the volume, and press .



| When alerts sound | Sound type |
|------------------------|-------------------------------------|
| Remaining battery low | 880Hz tone every 30 seconds 4 times |
| Recording starts | 1000Hz tone 1 time |
| Recording stops | 880Hz tone 2 times |
| Recording not possible | 880Hz tone 3 times |

HINT

- This can be set to Off or between -48 and -12 dBFs.
- When set to Off, no alerts will be output.

Timecode overview

The **F4** can input and output SMPTE timecode.

Timecode is time information written to data when recording video and audio. It is used for video editing, control of other devices, and synchronization of audio and video, for example.

Using timecode for editing

If video and audio data both have recorded timecode, aligning them to a timeline and synchronizing them together is easy when using nonlinear editing software for editing.

HINT

The **F4** uses a high-precision oscillator that enables the generation of accurate timecode with a discrepancy of less than 0.5 frames per 24 hours.

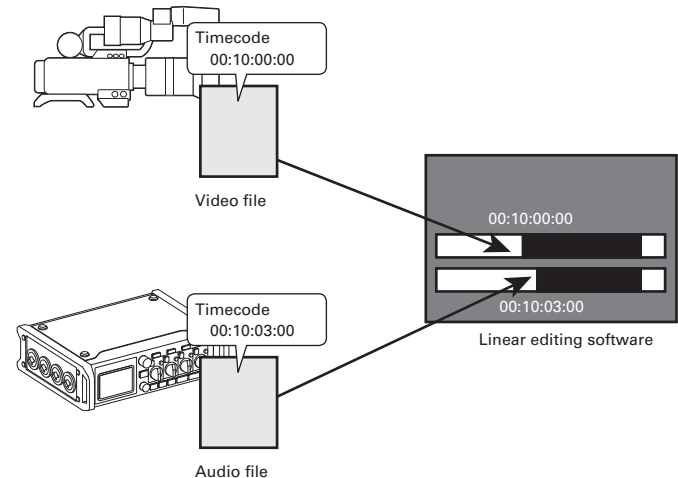

Timecode overview (continued)

Connection examples

According to application, connections like the following are possible.

Synchronizing with a video camera

The **F4** records with a mic input and transmits timecode. The **F4** records the timecode that it generates itself with the audio data. The timecode received by the video camera is recorded with the video data.

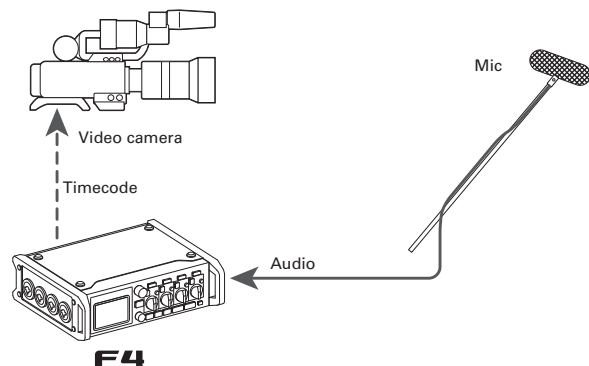

Inputting timecode

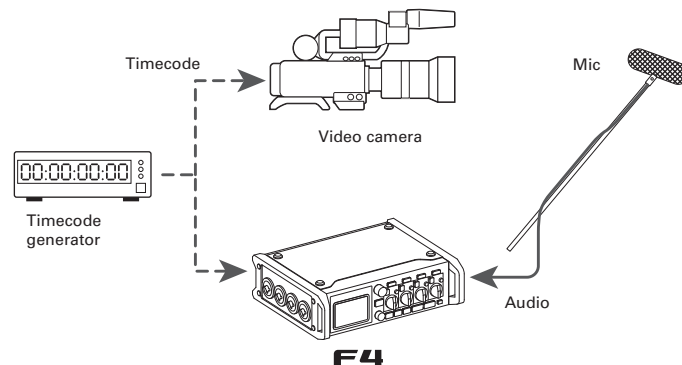

Timecode is transmitted from a timecode generator. Both the **F4** and the video camera receive timecode and record it with their audio and video data. The input timecode can also be used to synchronize the audio clock of the **F4**.



Making timecode settings

Various settings related to timecode can be set. These include whether it is sent or received and whether or not it is free running.

1. Press .

2. Use  to select TIMECODE (TC), and press .



3. Use  to select Mode, and press .

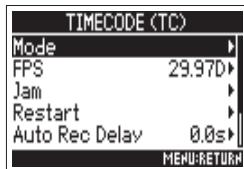

Setting the mode

4. Use  to select Mode, and press .

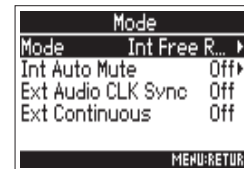

5. Use  to select the mode, and press .

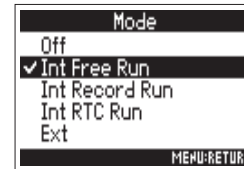

► Continue to one of the following procedures.

| | |
|---|-------|
| Setting the mode | P.105 |
| Stopping timecode output when recording is stopped..... | P.107 |
| Synchronizing audio clock with external timecode..... | P.107 |
| Automatically enabling internal timecode when no external timecode is input | P.108 |

Making timecode settings (continued)

| Setting value | Explanation |
|----------------|--|
| Off | No timecode will be written to the recording file. Timecode will not be output from the TIMECODE OUT jack. |
| Int Free Run | Internal timecode will be generated regardless of the recording mode. The internal timecode can be set manually using the following menu items. <ul style="list-style-type: none"> • MENU > TIMECODE (TC) > Jam • MENU > TIMECODE (TC) > Restart Timecode is always output from the TIMECODE OUT jack. |
| Int Record Run | Internal timecode will be generated only when recording. The internal timecode can be set manually using the following menu items. <ul style="list-style-type: none"> • MENU > TIMECODE (TC) > Jam • MENU > TIMECODE (TC) > Restart When switching from another mode, the internal timecode will stop at the last value. |
| Int RTC Run | Internal timecode will be generated regardless of the recording mode. In the following situations, the internal timecode will be synchronized (jammed) with the RTC (internal clock). <ul style="list-style-type: none"> • At startup • When Date/Time (RTC) changed (→ P.18) • When switching to this timecode mode Timecode is always output from the TIMECODE OUT jack. |
| Ext | The internal timecode will chase the external timecode. You can also enable the automatic generation of internal timecode when there is no external timecode. (→ P.108) |

| Setting value | Explanation |
|---------------|--|
| Ext Auto Rec | The internal timecode will chase the external timecode. You can also enable the automatic generation of internal timecode when there is no external timecode. (→ P.108) Recording starts automatically when external timecode input is detected. Recording stops automatically when external timecode stops. |

Stopping timecode output when recording is stopped

You can set whether or not timecode is output from the TIMECODE OUT jack when recording is stopped.

4. Use  to select Int Auto Mute, and press .

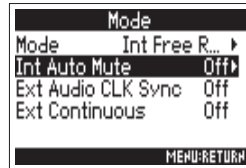

5. Use  to select On, and press .

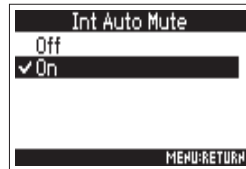



NOTE

- Timecode will continue to be output when recording/playback is paused.
- This cannot be set when Mode is set to Off, Ext or Ext Auto Rec.

Synchronizing audio clock with external timecode

The audio clock of the **F4** can be synchronized to the timecode input through the TIMECODE IN jack.

4. Use  to select Ext Audio Clock Sync, and press .

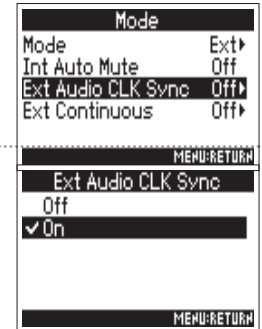

5. Use  to select On, and press .

NOTE

- When there is no external timecode, the internal audio clock is enabled to preserve continuity.
- This cannot be set when Mode is set to Off, Int Free Run, Int Record Run or Int RTC Run.

Making timecode settings *(continued)*

Automatically enabling internal timecode when no external timecode is input

You can enable the automatic generation of internal timecode to preserve continuity when there is no external timecode.

- 4.** Use  to select Ext Continuous, and press .

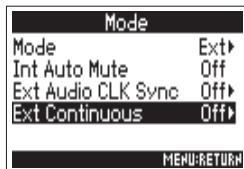

- 5.** Use  to select On, and press .

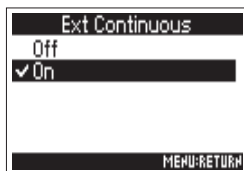

NOTE



- This cannot be set when Mode is set to Off, Int Free Run, Int Record Run or Int RTC Run.

Setting the frame rate for internal timecode (FPS)

Select the frame rate of the internal timecode. Select the setting most suitable for the video being synchronized and the application.

Setting the frame rate for internal timecode

1. Press .

2. Use  to select TIMECODE (TC), and press .



3. Use  to select FPS, and press .

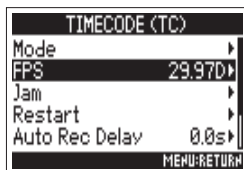

4. Use  to select the frame rate, and press .

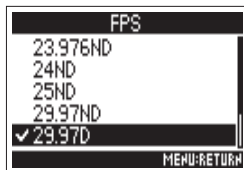

| Setting value | Explanation |
|---------------|--|
| 23.976ND | This is the most common frame rate used with HD cameras and other high-definition video recording. The count is slower than the actual time by 0.1%. |
| 24ND | This is the standard frame rate used for recording film. This is also used with HD cameras. |
| 25ND | This is the frame rate for PAL video. This is used for PAL video, which is used in Europe and other regions. |
| 29.97ND | This is a frame rate used for NTSC color video and HD cameras. The count is slower than the actual time by 0.1%. This is used for NTSC video, which is used in Japan, the United States and other countries. |
| 29.97D | This is an adjusted frame rate that uses a drop frame to make NTSC match the actual time. This is used with video for broadcast that requires the actual time frame to be matched. |
| 30ND | This is used to synchronize sound with film that is being transferred to NTSC video. This is the standard frame rate used for black-and-white television in Japan, the United States and other countries. |
| 30D | This rate is used for special applications. This synchronizes at 29.97 fps drop frame with film sound to be transferred to NTSC. The count is faster than the actual time by 0.1%. |

NOTE

Frame rates must be set in advance to match on devices used for all video and audio data.



Jamming internal timecode (Jam)

Timecode input through the TIMECODE IN jack is used to set internal timecode

1. Press .

2. Use  to select TIMECODE (TC), and press .



3. Use  to select Jam, and press .

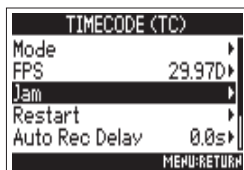

4. Use  to select "Yes", and press .

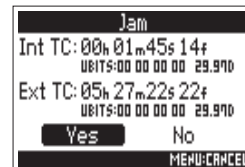



Restarting internal timecode with a specified value (Restart)

You can freely change the internal timecode setting value and restart from that value.

1. Press .

2. Use  to select TIMECODE (TC), and press .



3. Use  to select Restart, and press .

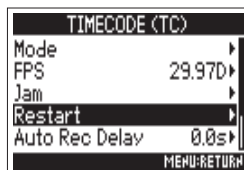

4. Change the restart value.



- Editing operations

Move cursor or change value:

Turn .

Select parameter to change: Press .





5. When done changing the setting, use  to select Restart, and press .





Setting the automatic timecode recording delay (Auto Rec Delay)

If set to record automatically when external timecode is received, unnecessary recording could occur if timecode is received for a brief amount time. In order to prevent this, you can set the amount of time until recording starts after timecode is received.

1. Press .

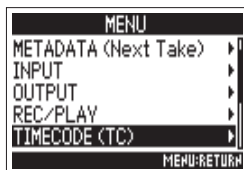
2. Use  to select TIMECODE (TC), and press .



3. Use  to select Auto Rec Delay, and press .

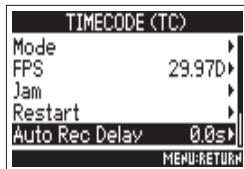

4. Use  to adjust the time, and press .



HINT

This can be set from 0.0 to 8.0 s.

Setting the user bits for internal timecode (Ubits)

User bits are data that you can set to be included in the timecode. Up to 8 numbers (0–9) and letters (A–F) can be included. Recording date information, for example, can be useful when editing later.

1. Press .

2. Use  to select TIMECODE (TC), and press .



3. Use  to select Ubits, and press .

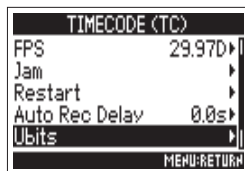

► Continue to one of the following procedures.

- Setting the user bits (Ubits) mode P.113
- Setting the user bits (Ubits) P.114

Setting the user bits (Ubits) mode

4. Use  to select Ubits, and press .

5. Use  to select Mode, and press .



6. Use  to select the mode, and press .



| Setting value | Explanation |
|---------------|---|
| uu uu uu uu | You can set these values as you like on the Edit screen. |
| mm dd yy uu | The month, day and year are entered automatically in that order using the RTC setting. You can set the "uu" value as you like on the Edit screen. |
| dd mm yy uu | The day, month and year are entered automatically in that order using the RTC setting. You can set the "uu" value as you like on the Edit screen. |
| yy mm dd uu | The year, month and day are entered automatically in that order using the RTC setting. You can set the "uu" value as you like on the Edit screen. |

HINT

Only "uu" items can be changed on the Edit screen.

Setting the user bits for internal timecode (Ubits) (continued)

Setting the user bits (Ubits)

4. Use  to select Edit, and press .



5. Change the value.



- Editing operations

Move cursor or change value:

Turn .

Select parameter to change: Press .



6. When done changing the setting, use  to select Enter, and press .

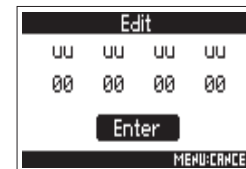



HINT

This can be set using numbers from 0 to 9 and letters from A to F.

Setting how timecode is initialized at startup (Start Timecode)

When the **F4** is turned off, the internal timecode stops, so the timecode is automatically initialized (jammed) during startup. You can set the value that is used for jamming at that time.



1. Press .

2. Use  to select TIMECODE (TC), and press .

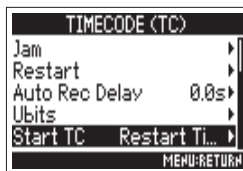

3. Use  to select Start TC, and press .



4. Use  to set how timecode is initialized, and press .



| Setting value | Explanation |
|---------------|---|
| RestartTime | When the F4 starts, the value set by Restart (→ P.111) is used to jam the internal timecode. |
| RTC | When the F4 starts, its timecode is restored from the timecode when the power was turned off and advanced by the elapsed time using the Date/Time (RTC) setting (→ P.18). Since RTC is less precise than internal timecode, discrepancies will occur. |

Using slate tones (Slate Tone)

The **F4** can add tones while recording. These are called slate tones.

By adding a slate tone when the recording starts, aligning it to a video file during editing will be easier.

The **F4** also has the ability to output slate tones. This function can be used to match the levels of connected equipment.

1. Press .

2. Use  to select SLATE TONE, and press .

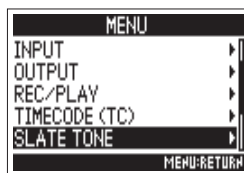

▶ Continue to one of the following procedures.

| | |
|------------------------------|-------|
| Setting the volume | P.116 |
| Setting the frequency | P.117 |
| Setting the routing..... | P.117 |
| Recording a tone..... | P.118 |
| Enabling the slate tone..... | P.118 |

HINT

A "slate" is a clapperboard used when recording video.

NOTE

The slate tone cannot be used during audio file playback.

Setting the volume

3. Use  to select Level, and press .



4. Use  to adjust the level, and press .



HINT

This can be set from -20 to 0 dBFS.

Setting the frequency

3. Use to select Frequency, and press .

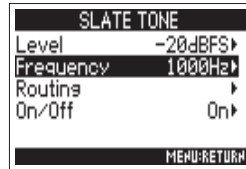

4. Use to adjust the frequency, and press .



HINT

This can be set from 100 to 10,000 Hz.

Setting the routing

Set the destination for the slate tone signal.

3. Use to select Routing, and press .

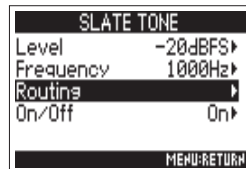

4. Use to select the tracks/outputs for slate tone signal routing, and press .

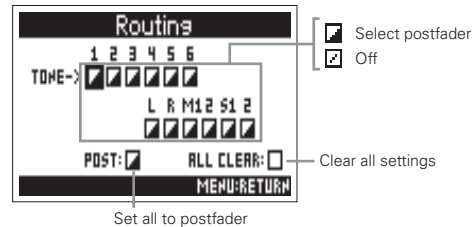

NOTE

Routing to tracks 1–6 is not possible when operating as an audio interface (Stereo Mix).

HINT

Press to switch between Postfader and Off.

5. Press .

Using slate tones (Slate Tone) (continued)

Recording



3. Press  to start recording.

4. Press .

NOTE

- When the slate tone is sounding, other signals input to tracks that it is routed to are muted.
- The slate signal is output from the headphone L/R channels regardless of routing settings.
- The MAIN OUT 1/2 and SUB OUT 1/2 faders do not affect the level of the slate tone.
- The SLATETONE indicator lights when the slate tone is sounding.

HINT

Press  for at least one second to enable slate tone input continuously. Press  again to disable it.

Disabling the slate tone

To prevent accidental recording due to misoperation, you can disable the  button.

3. Use  to select On/Off, and press .



4. Use  to select Off (Lock), and press .

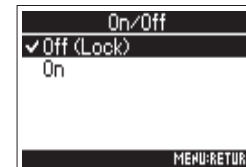



Exchanging data with a computer (SD Card Reader)



By connecting with a computer, you can check and copy data on the cards.

Connecting with a computer

1. Press .

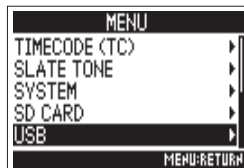
2. Use  to select USB,
and press .



3. Use  to select SD Card
Reader, and press .



4. Use a USB cable to connect the **F4** and the computer.

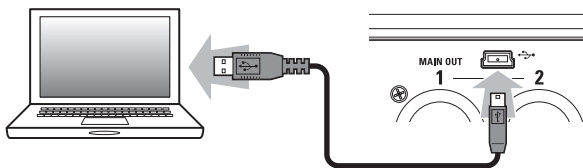

NOTE

- The supported operating systems are as follows.
Windows: Windows 7 or later
Mac OS: Mac OS X (10.8 or later)
- The **F4** cannot operate on USB bus power. Use AA batteries or a DC power supply.

HINT

When the **F4** is connected to a computer, the SD cards loaded in slots 1 and 2 are recognized as separate SD cards.

Disconnecting

1. Disconnect on the computer.

Windows:
Select **F4** from "Safely Remove Hardware".
Mac OS:
Drag and drop the **F4** icon into the Trash.

NOTE

Always conduct computer disconnection procedures before disconnecting the USB cable.



2. Disconnect the cable from the computer and the **F4**, and press .

Using as an audio interface (Audio Interface)

F4 input signals can be input directly to a computer or iOS device, and playback signals on a computer or iOS device can be output from the **F4**.

Connecting with a computer or iOS device

1. Press .

2. Use  to select USB, and press .

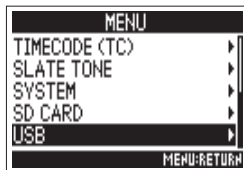

3. Use  to select Audio Interface, and press .

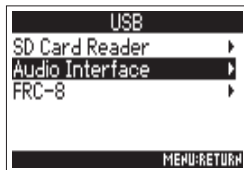

4. Use  to select the mode and connected device, and press .



| Setting value | Explanation |
|--------------------------|---|
| Stereo Mix (PC/Mac) | This is a 2-in/2-out connection mode for Mac/Windows and sends tracks 1-6 as a stereo mix. |
| Stereo Mix (iOS Devices) | This is a 2-in/2-out connection mode for iOS devices and sends tracks 1-6 as a stereo mix. |
| Multi Track (PC/Mac) | This is a 6-in/4-out connection mode for Mac/Windows and sends tracks 1-6 as separate signals (cannot be used with iOS devices). A driver is necessary for use with Windows. Download the driver from the ZOOM website (www.zoom.co.jp/). |

5. Use a USB cable to connect the **F4** and the iOS device.

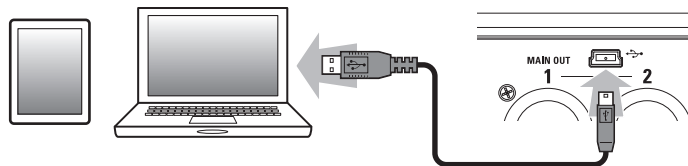



NOTE



- A Lightning to USB Camera Adapter is necessary to connect an iOS device.
- The **F4** cannot operate on USB bus power. Use AA batteries or a DC power supply.

Disconnecting

1. Press .

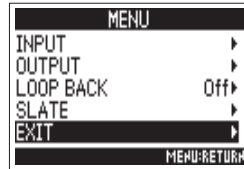
2. Use  to select EXIT,
and press .



3. Use  to select "Yes",
and press .



4. Disconnect the cable from the computer or iOS device
and the **F4**.

Audio interface block diagrams

Stereo Mix

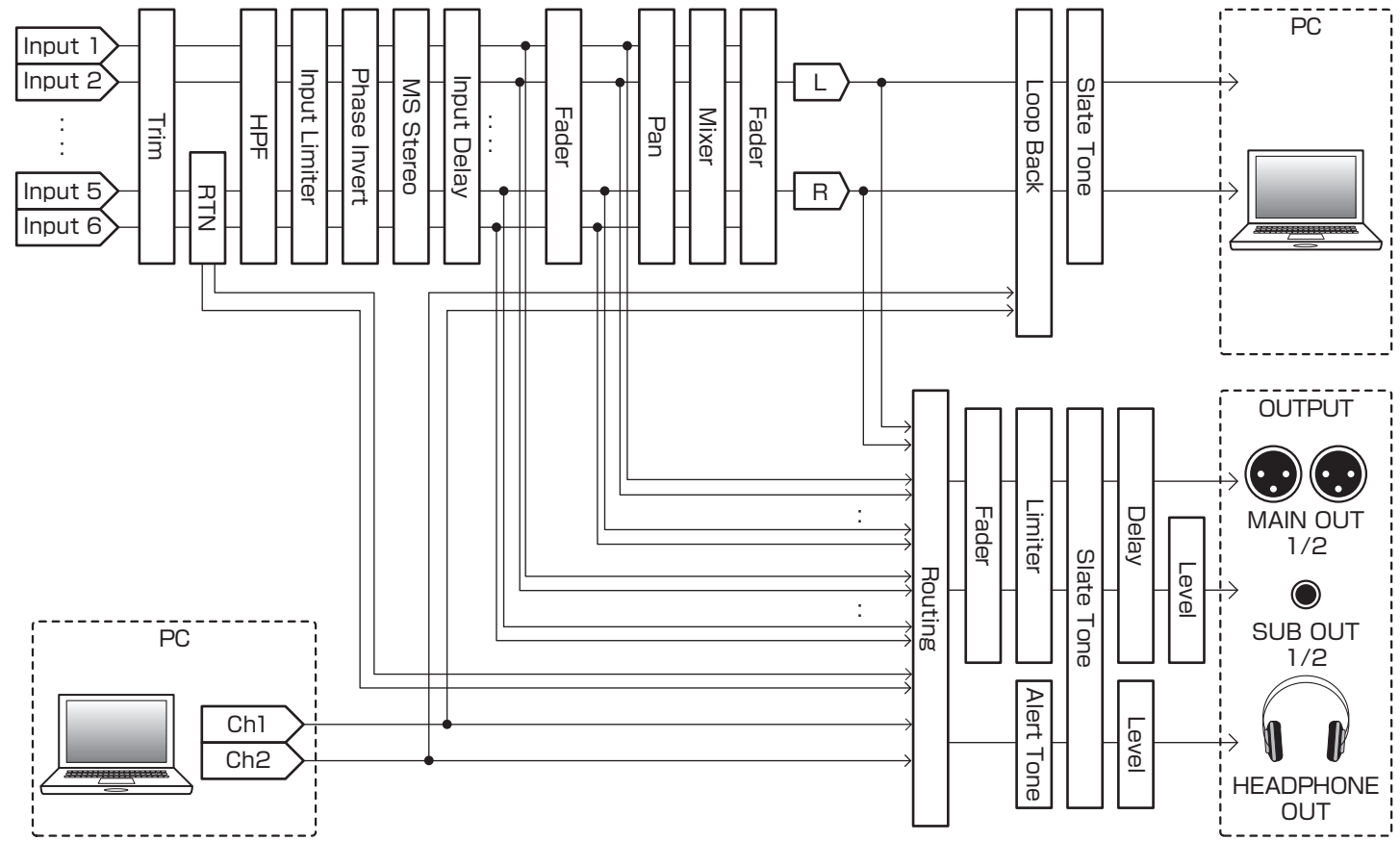

Multi Track

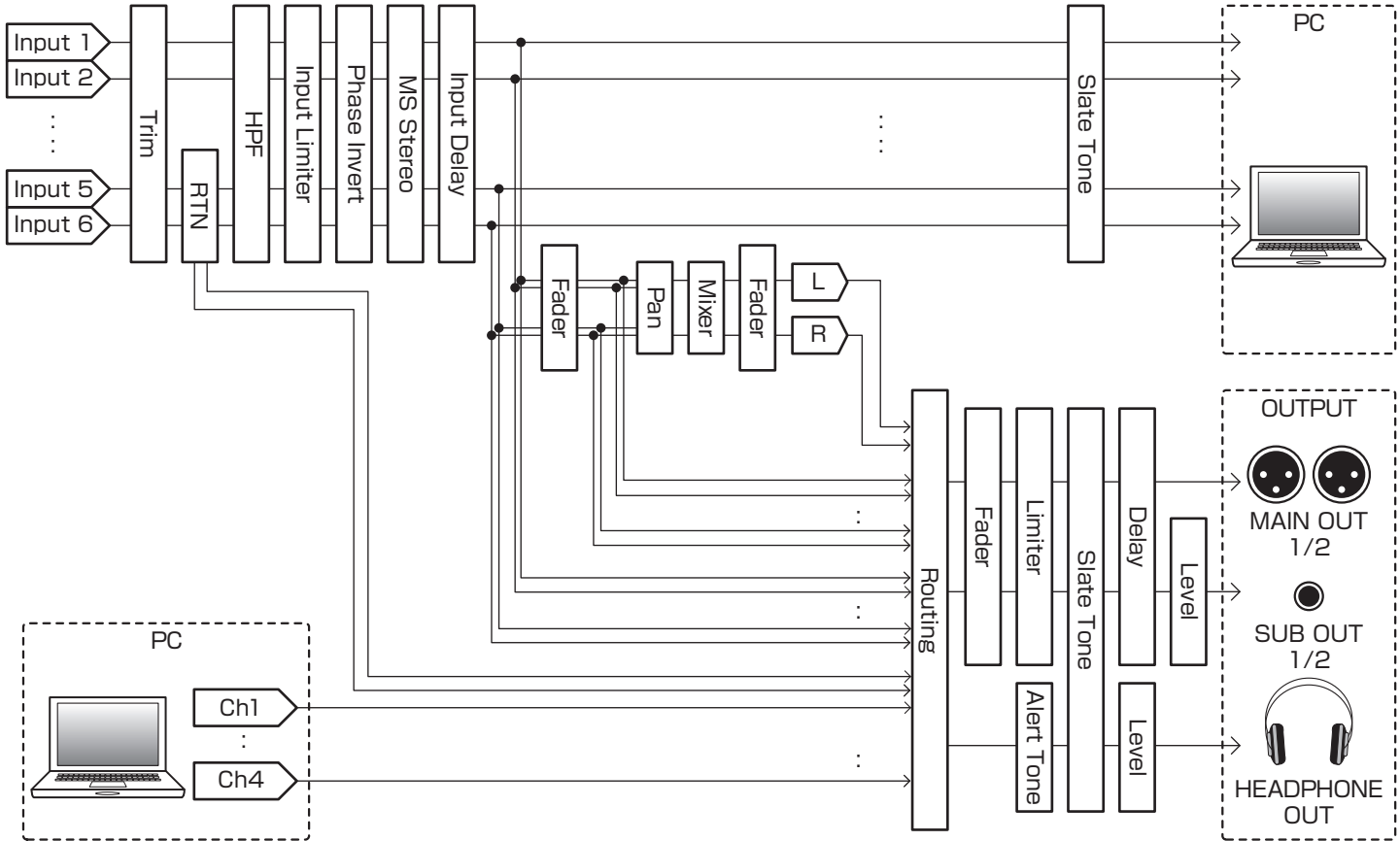

Audio interface settings

The following settings can be made when using the **F4** as an audio interface. See the relevant pages for details about operation.

Setting loop back (Stereo Mix only)

This function allows the playback sound from the computer or iOS device and the **F4** inputs to be mixed and sent back to the computer or iOS device (loop back).

You can use this function to add narration to music played back from the computer and record the mix or stream it on the computer, for example.

1. Press .

2. Use  to select LOOP BACK, and press .

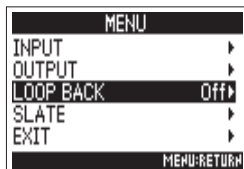

3. Use  to select On, and press .

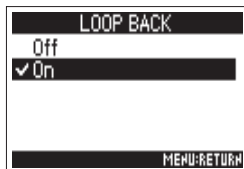

Mixing inputs

You can adjust the mix balance of the inputs. Input signals will be sent to the computer or iOS device using the balance settings made here. When using a Stereo Mix setting, the mixed stereo signal will be sent.

1. Open the mixer on the Home

Screen. (→ P.11)

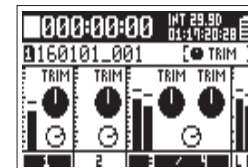

2. Adjust the parameter settings.

See "Adjusting the input levels and monitoring balance" (→ P.27) for how to change settings.

Using an **FRC-8** as a controller (Connect)

By connecting the **FRC-8** to the **F4**, you can use it to adjust trim, fader and pan settings, for example.

1. Press .

2. Use  to select USB,
and press .

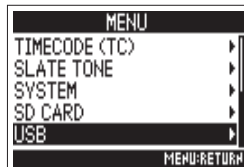

3. Use  to select FRC-8,
and press .



► Continue to one of the following procedures.

| | |
|---------------------|-------|
| Connecting | P.125 |
| Disconnecting | P.125 |

Connecting

4. Use  to select Connect,
and press .



5. Use  to select "Yes",
and press .



6. Use a USB cable to connect the **F4** and the **FRC-8**.

7. Turn the **FRC-8** power ON.

NOTE

When disconnecting the FRC-8, select "Disconnect" before unplugging the USB cable

Setting the **FRC-8** connected keyboard type (Keyboard type)

A computer keyboard can be connected to the **FRC-8** and used to input characters. Set the type of computer keyboard connected to use it.

1. Press .

2. Use  to select USB, and press .

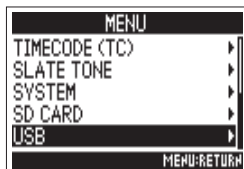

3. Use  to select FRC-8, and press .

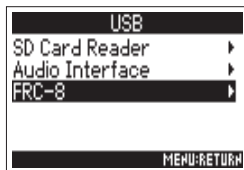

4. Use  to select Keyboard Type, and press .

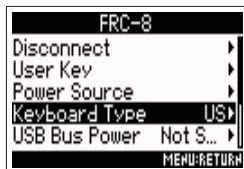

5. Use  to select the type, and press .





| Setting value | Explanation |
|---------------|---------------------------------------|
| US | Use for an English-language keyboard. |
| JP | Use for a Japanese-language keyboard. |

Setting user keys for the FRC-8 (User Key)

You can assign functions to the **FRC-8** user keys.

1. Press .

2. Use  to select USB,
and press .

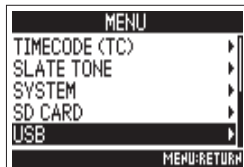

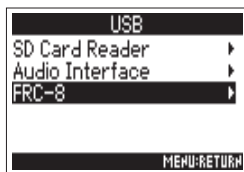

3. Use  to select FRC-8,
and press .



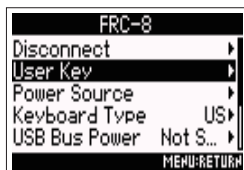

4. Use  to select User Key,
and press .



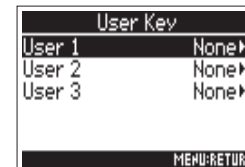

5. Use  to select the key to
which to assign a function,
and press .



6. Use  to select the func-
tion to assign, and press .





| Function | Explanation |
|----------------------|--|
| None | No function is assigned. |
| Tone | Generate and stops slate tones. |
| Mark | Add marks to WAV format takes during recording and playback. |
| Set Trim Link | Open the MENU > INPUT > Trim Link screen. |
| Knob Lock | Disable adjustments using  . |
| Clear Clip Indicator | Clear the level meter clipping indicators. |
| Circled | Circle the currently selected take. |
| Option | Function as the F4  button. |

Setting the power supply used by the **FRC-8** (Power Source)

Set the DC power supply shutdown voltage, nominal voltage and type of batteries so that the remaining power supply charge can be shown accurately.

On this menu page, you can check the voltage of each power supply and the remaining battery capacity.

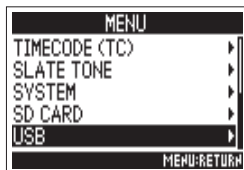

1. Press .

2. Use  to select USB,
and press .

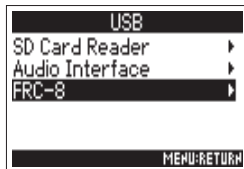

3. Use  to select FRC-8,
and press .



4. Use  to select Power
Source, and press .

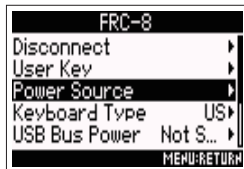

Setting the power source for the **FRC-8** is the same as for the **F4**. See "Setting the power supply used (Power Source)" (→ P.20).

► Continue to one of the following procedures.

Setting the DC power supply (Ext DC) shutdown voltage P.20

Setting the DC power supply (Ext DC) nominal voltage..... P.21

Setting the type of AA batteries (Int AA)..... P.21

NOTE

When multiple power supplies are connected, they will be used in the following order of precedence.

1. DC power supply (Ext DC)
2. USB bus power (supplied by **F4**)
3. AA batteries (Int AA)

The voltages of each power supply are shown on the display.

Powering the **FRC-8** with USB bus power (USB Bus Power)

The **F4** can supply USB bus power to the **FRC-8**.

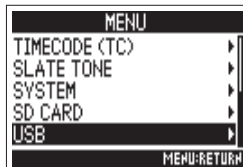

1. Press .

2. Use  to select USB,
and press .





3. Use  to select FRC-8,
and press .



4. Use  to select USB Bus
Power, and press .



5. Use  to select Supply to
FRC-8, and press .

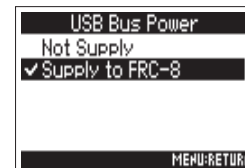



NOTE

When the **F4** is supplying bus power, do not connect any device other than an **FRC-8** to the USB port. Doing so could damage the **F4** and the connected device.

Setting the **FRC-8** LED brightness (LED Brightness)

You can adjust the brightness of the LEDs on the **FRC-8**.

1. Press .

2. Use  to select USB, and press .

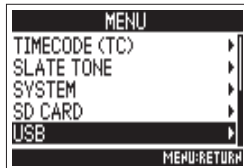

3. Use  to select FRC-8, and press .

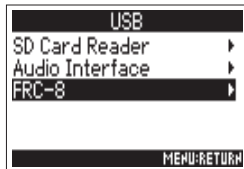

4. Use  to select LED Brightness, and press .

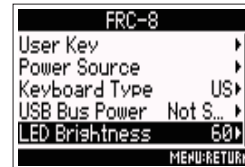

5. Use  to adjust the brightness, and press .



Updating the FRC-8 firmware

You can check the **FRC-8** firmware version and update it to the latest version.

An update file for the latest version can be downloaded from the ZOOM website (www.zoom.co.jp).

1. Connect the **F4** and the **FRC-8**, referring to "Using an **FRC-8** as a controller (Connect)" (→ P.125).

NOTE

Updating the firmware is not possible if the remaining battery or DC power supply charge is low. In this case, replace the batteries with new ones or use a charged DC power supply.

2. Copy the file for updating the firmware to the root directory on an SD card.

3. Load the SD card into the SD CARD 1 slot.

NOTE

If an SD card is loaded in the SD CARD 2 slot, eject it.

4. Press .

5. Use  to select USB, and press .

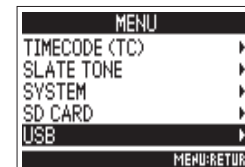

6. Use  to select FRC-8, and press .

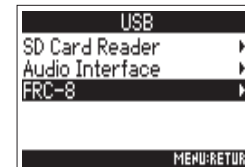



- ▶ Continue to one of the following procedures.

| | |
|-------------------------------------|-------|
| Checking the firmware version | P.132 |
| Updating the firmware | P.132 |



Updating the FRC-8 firmware (continued)

Checking the firmware version

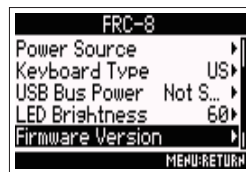
7. Use  to select Firmware Version, and press .



Updating the firmware

7. Use  to select Update Firmware, and press .



8. Use  to select "Yes", and press .



NOTE

Do not turn the power off, remove an SD card or disconnect the USB cable during a firmware update. Doing so could cause the **FRC-8** to become unstartable.

9. After the firmware update completes, turn the **FRC-8** power off.



Setting the level meter display (Level Meter)

You can set how the level meters appear on the display.

1. Press .

2. Use  to select SYSTEM, and press .

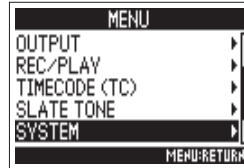

3. Use  to select Level Meter, and press .

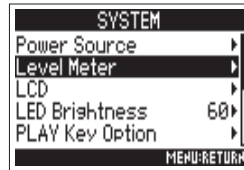

Setting the type

You can set whether the level meters use VU or Peak style.

4. Use  to select Type, and press .

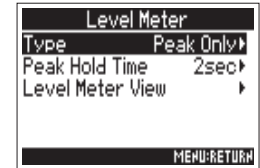

5. Use  to select the type, and press .

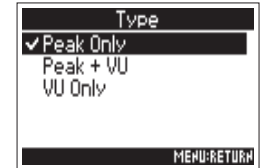



▶ Continue to one of the following procedures.

- Setting the type..... P.133
- Setting the peak hold time P.134
- Setting the track level meters shown on the Home Screen P.135

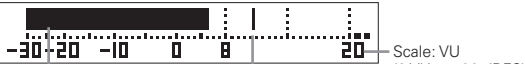
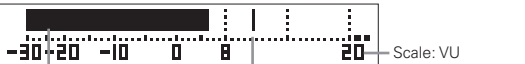
Setting the level meter display (Level Meter) (continued)

| Setting value | Explanation |
|---------------|--|
| Peak Only |  <p>Scale: dBFS</p> <p>Peak value shown Peak value held for set time</p> <p>The actual peak level of the signal (dBFS) is shown.</p> |
| VU + Peak |  <p>Scale: VU (0 VU = -20 dBFS)</p> <p>VU value shown Peak value held for set time</p> <p>Both VU and peak level are shown simultaneously. In this mode, the bars show VU and the dots above the VU show the peak.</p> |
| VU Only |  <p>Scale: VU (0 VU = -20 dBFS)</p> <p>VU value shown VU value held for set time</p> <p>This display style is close to human hearing.</p> |

Setting the peak hold time

4. Use  to select Peak Hold Time, and press .

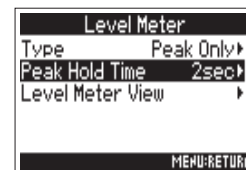

5. Use  to adjust the peak hold time, and press .

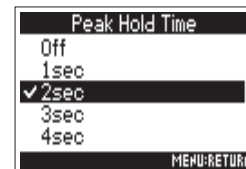

Setting the track level meters shown on the Home Screen

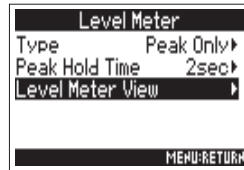

You can change which tracks are shown on the Home Screen.

- 4.** Use  to select **Level Meter View**, and press .

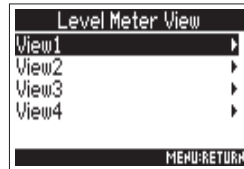

- 5.** Use  to select **View 1-4**, and press .



- 6.** Use  to select the tracks to show, and press .

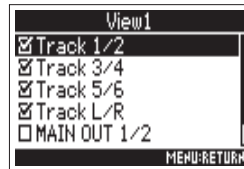

NOTE

A maximum of four can be selected

HINT

- Multiple tracks can be shown. Not showing any tracks is also possible.
- If none of the check boxes are checked, no track level meters will appear on the Home Screen.

- 7.** Press .

Making display settings (LCD)

You can make settings related to the display.

1. Press .

2. Use  to select **SYSTEM**,
and press .

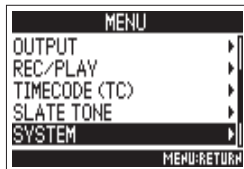

3. Use  to select **LCD**,
and press .

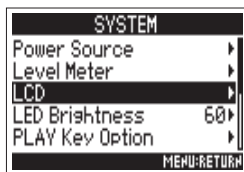

▶ Continue to one of the following procedures.

Changing the display backlight setting..... P.136

Adjusting the display contrast..... P.137

Changing the Home Screen timecode display..... P.137

Changing the display backlight setting

You can set the display backlight to turn off after a set amount of time without use.

4. Use  to select **Backlight**,
and press .



5. Use  to select the setting,
and press .



Adjusting the display contrast

4. Use  to select Contrast, and press .



5. Use  to adjust the contrast, and press .



HINT

This can be set from 1 to 10.

Changing the Home Screen timecode display



You can change the size of the timecode shown on the Home Screen.

4. Use  to select Home TC Size, and press .



5. Use  to select the size, and press .



| Setting value | Explanation |
|---------------|--|
| Small |  <p>The timecode is small and the time counter is large.</p> |
| Big |  <p>The timecode is large and the time counter is small.</p> |

Setting the LED brightness (LED Brightness)

You can adjust the brightness of the LEDs on the front of the **F4**.

1. Press .

2. Use  to select SYSTEM, and press .

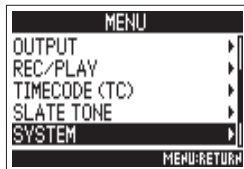

3. Use  to select LED Brightness, and press .

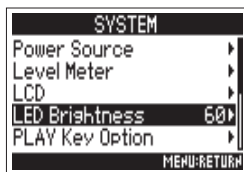

4. Use  to adjust the brightness, and press .

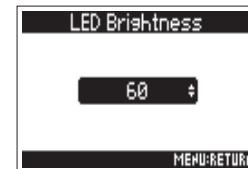

HINT

This can be set from 5 to 100.



Setting how marks are added manually (PLAY Key Option)

You can set how marks are added when  is pressed while recording or playing back a WAV format file.

1. Press .

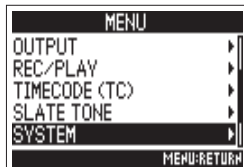
2. Use  to select SYSTEM, and press .



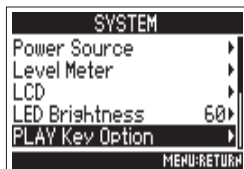

3. Use  to select PLAY Key Option, and press .

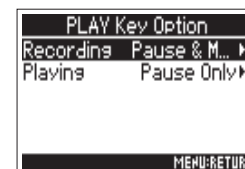

Setting how marks are added when recording

4. Use  to select Recording, and press .



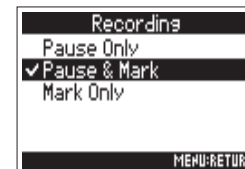

5. Use  to select how marks are added, and press .



▶ Continue to one of the following procedures.

Setting how marks are added when recording P.139

Setting how marks are added when playing P.140



| Setting value | Explanation |
|---------------|--|
| Pause Only | Pressing  will pause without adding a mark. |
| Pause & Mark | Pressing  will pause and add a mark. |
| Mark Only | Pressing  will add a mark without pausing. |

Setting how marks are added manually (PLAY Key Option) (continued)

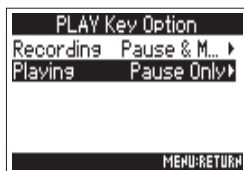

Setting how marks are added when playing

- 4.** Use  to select Playing, and press .



- 5.** Use  to select how marks are added, and press .



| Setting value | Explanation |
|---------------|--|
| Pause Only | Pressing  will pause without adding a mark. |
| Pause & Mark | Pressing  will pause and add a mark. |
| Mark Only | Pressing  will add a mark without pausing. |

Checking SD card information (Information)

You can check the size and open space of SD cards.

1. Press .

2. Use  to select SD CARD, and press .

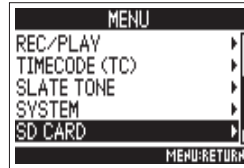

3. Use  to select Information, and press .

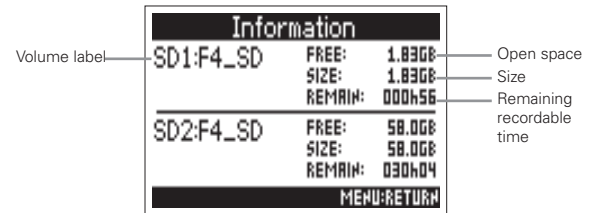
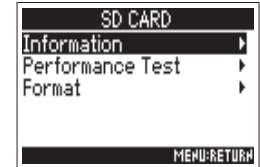



Testing SD card performance (Performance Test)

You can test whether an SD card can be used with the **F4**. A basic test can be done quickly, while a full test examines the entire SD card.

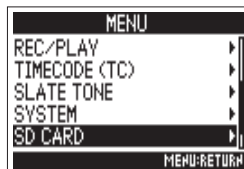

1. Press .

2. Use  to select SD CARD, and press .

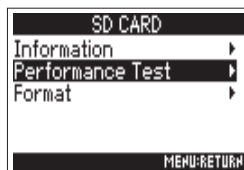

3. Use  to select Performance Test, and press .



4. Use  to select the SD card to test, and press .



▶ Continue to one of the following procedures.

Conducting a quick test..... P.142

Conducting a full test P.143

Conducting a quick test

5. Use  to select Quick Test, and press .

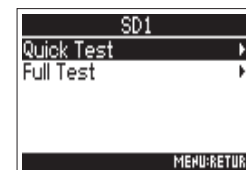

6. Use  to select "Yes", and press .

The card performance test will start. The tests should take about 30 seconds.

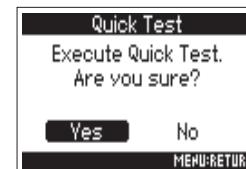

7. The test completes.

The result of the evaluation will be shown.

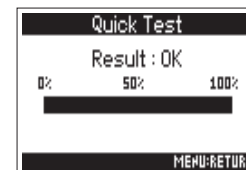

8. Press  to cancel the test.

NOTE

Even if a performance test result is "OK", there is no guarantee that writing errors will not occur. This information is just to provide guidance.

Conducting a full test

- 5.** Use  to select Full Test, and press .

The amount of time required for the full test will be shown.

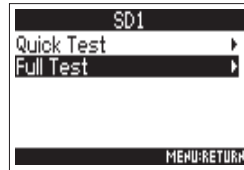

- 6.** Use  to select "Yes", and press .

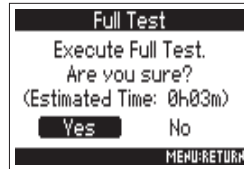

- 7.** The test completes.

The result of the evaluation will be shown. If the access rate MAX reaches 100%, the card will fail (NG).



- 8.** Press  to cancel the test.

NOTE

- You can press  to pause and resume the test.
- Even if a performance test result is "OK", there is no guarantee that writing errors will not occur. This information is just to provide guidance.

Formatting SD cards (Format)

Format SD cards for use with the **F4**.

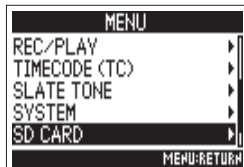

1. Press .

2. Use  to select SD CARD, and press .



3. Use  to select Format, and press .



4. Use  to select the card to format, and press .



5. Use  to select "Yes", and press .



NOTE

- Before using SD cards that have just been purchased or that have been formatted on a computer, they must be formatted by the **F4**.
- Be aware that all data previously saved on the SD card will be deleted when it is formatted.

Checking the **F4** shortcut list (Shortcut List)

The **F4** has a shortcut feature that allows quick access to various functions.
See the "List of shortcuts" (→ P.156) to check the shortcut functions.

1. Press .

2. Use  to select **SYSTEM**,
and press .

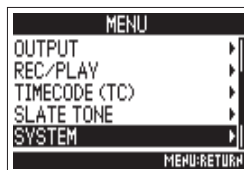

3. Use  to select **Shortcut**

List, and press .

Use  to scroll the screen and show information that is hidden.

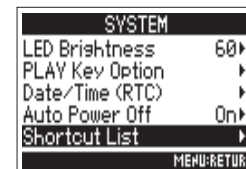



Restoring default setting values (Factory Reset)

You can restore the factory default settings.

1. Press .

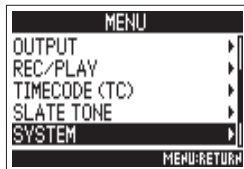
2. Use  to select SYSTEM, and press .



3. Use  to select Factory Reset, and press .

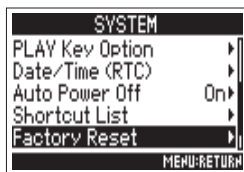

4. Use  to select "Yes", and press .

The settings will be reset and the power will automatically turn off.





Checking the firmware version (Firmware Version)

You can check the firmware version.

1. Press .

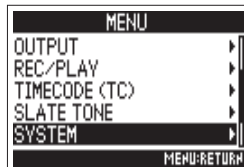
2. Use  to select SYSTEM,
and press .



3. Use  to select Firmware
Version, and press .

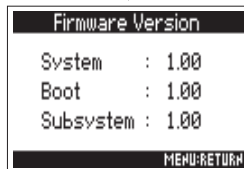

Updating the firmware

The **F4** firmware can be updated to the latest version.

An update file for the latest version can be downloaded from the ZOOM website (www.zoom.co.jp).

1. Install new batteries in the **F4** or connect a charged DC power supply to the DC IN connector.

NOTE

Updating the firmware is not possible if the remaining battery or DC power supply charge is low. In this case, replace the batteries with new ones or use a charged DC power supply.

2. Copy the file for updating the firmware to the root directory on an SD card.

3. Load the SD card into the SD CARD 1 slot, and turn the power on while pressing .

NOTE

If an SD card is loaded in the SD CARD 2 slot, eject it.

4. Use  to select "Yes", and press .

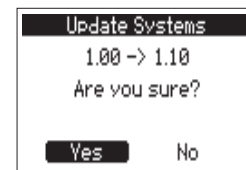

NOTE

Do not turn the power off or remove the SD card during a firmware update. Doing so could cause the **F4** to become unstartable.

5. After the firmware update completes, turn the power off.

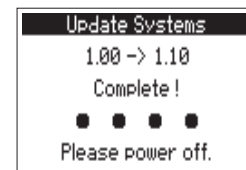

Troubleshooting

If you think that the **F4** is operating strangely, check the following items first.

Recording/playback trouble

◆ There is no sound or output is very quiet

- Check the connections to your monitoring system and its volume setting.
- Confirm that the volume of the **F4** is not too low.

◆ Sound from connected equipment or inputs cannot be heard or is very quiet

- If you are using a mic capsule, confirm that it is oriented correctly.
- Check the input level settings. (→ P.27)
- If a CD player or other device is connected to an input jack, raise the output level of that device.
- Check the input signal monitoring settings. (→ P.27)
- Check the phantom power and plug-in power settings. (→ P.80, P.83)
- Check the headphones, MAIN OUT 1/2 and SUB OUT 1/2 routing settings. (→ P.90)

◆ Recording is not possible

- Confirm that the track keys are lit red.
- Confirm that the SD card has open space. (→ P.141)
- Confirm that an SD card is loaded properly in a card slot.
- If "Card Protected!" appears on the display, the SD card write-protection is enabled. Slide the lock switch on the SD card to disable write-protection.

◆ The recorded sound cannot be heard or is very quiet

- Confirm that the volume levels of the tracks are not too low. (→ P.50)
- Confirm that the track keys are lit green during playback.

Other trouble

- ◆ Computer does not recognize it even though it is connected to the USB port.
 - Confirm that the operating system is compatible. (→ P.119)
 - The operation mode must be set on the **F4** to allow the computer to recognize the **F4**. (→ P.119)

◆ Battery operation time is short

- Making the following settings could increase the battery operation time.
- Set the power supply used correctly. (→ P.20)
 - Turn unnecessary tracks off. (→ P.25)
 - Turn unnecessary outputs off. (→ P.94)
 - Set the phantom power voltage to 24V. (→ P.80)
 - Disable phantom power during playback. (→ P.82)
 - Turn timecode off if not using it. (→ P.105)
 - Reduce the LED brightness. (→ P.138)
 - Turn the display backlight off. (→ P.136)
 - Reduce the sampling rate used to record files. (→ P.30)
 - Due to their characteristics, using nickel metal hydride batteries (especially high-capacity ones) or lithium batteries should enable longer use than alkaline batteries when power consumption is high.

Detailed product diagrams

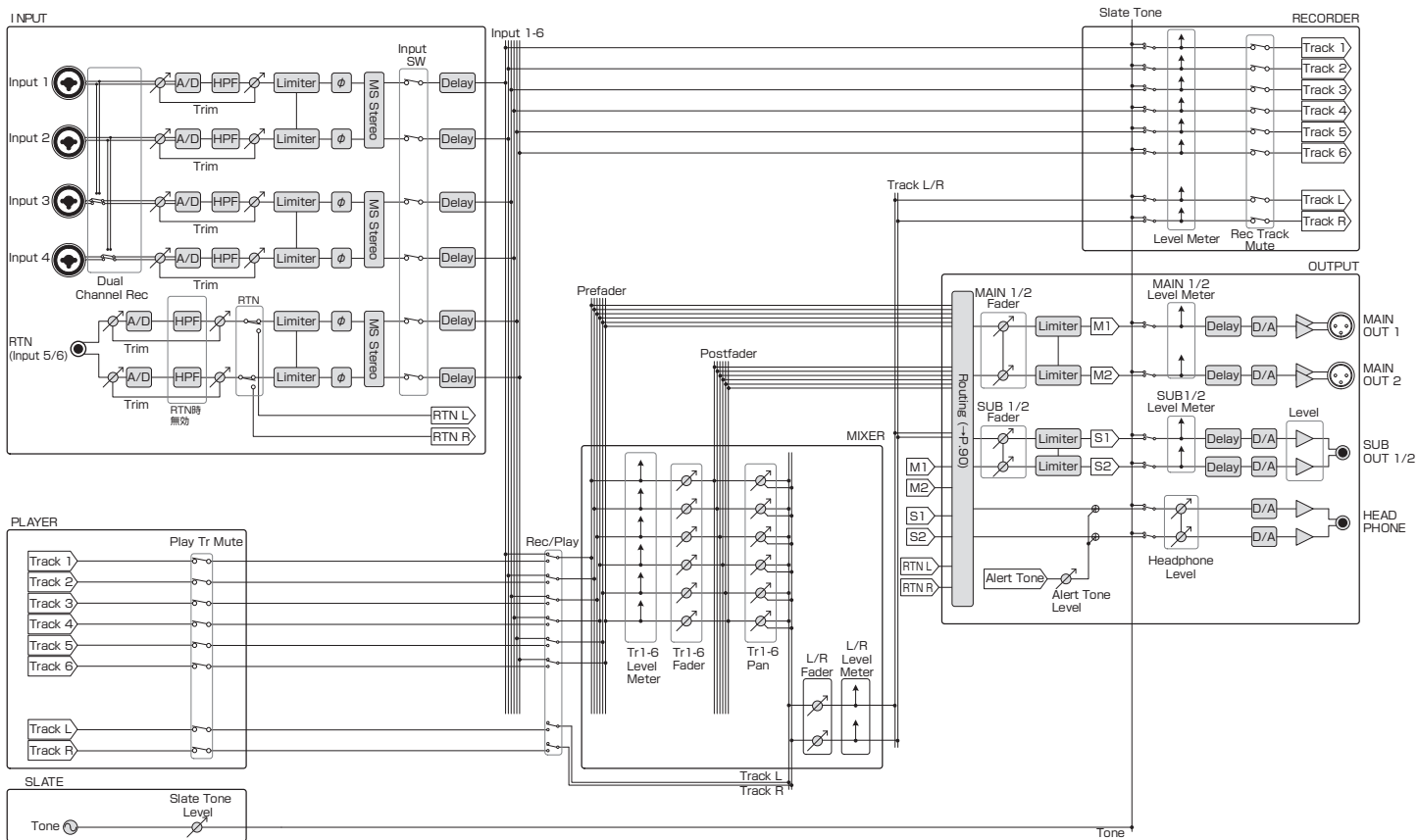

Routing

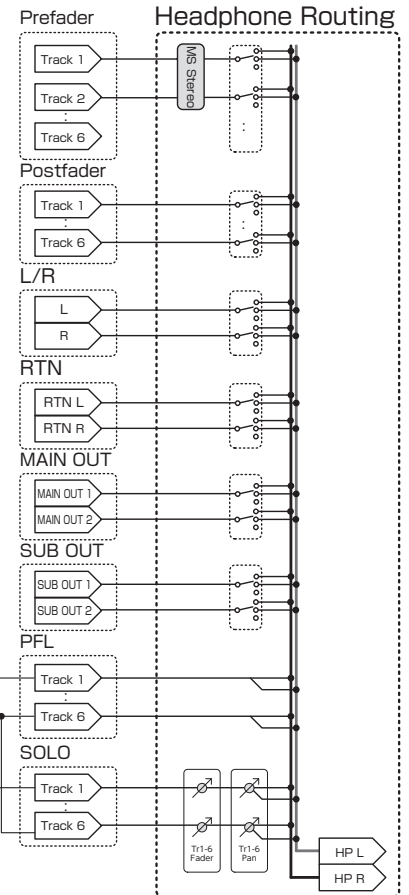
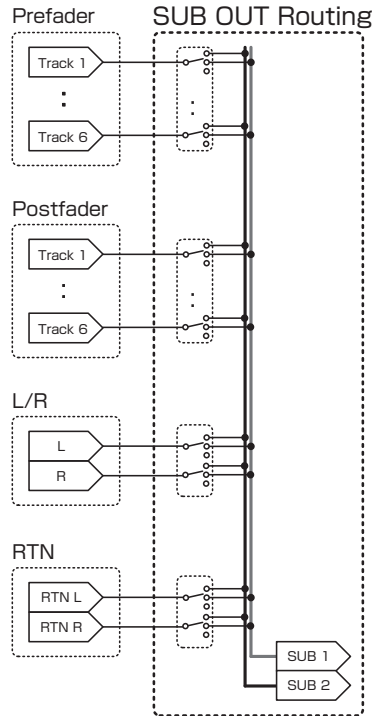
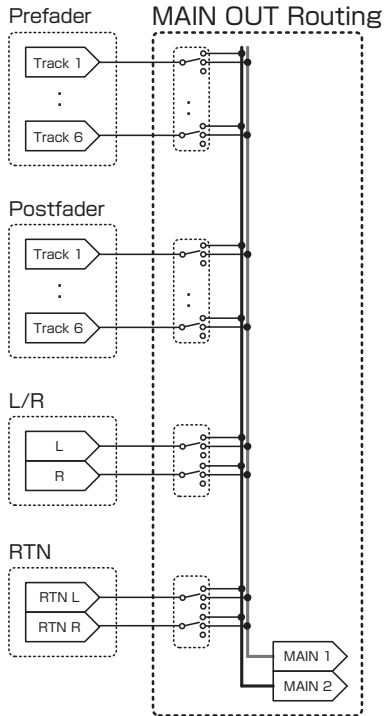

Metadata list

Metadata contained in BEXT chunks in WAV files

| Tag | Explanation | Remarks |
|----------|--------------------------------------|---|
| SPEED= | Frame rate | MENU > TIMECODE (TC) > FPS |
| TAKE= | Take number | |
| UBITS= | User bits | MENU > TIMECODE (TC) > Ubits |
| SCENE= | Scene name | MENU > METADATA (NextTake) > Scene > Name Mode MENU > METADATA (NextTake) > Scene > User Scene Name MENU > FINDER > TAKE MENU > Metadata Edit > Scene |
| TAPE= | Name of recording destination folder | MENU > FINDER MENU > FINDER > TAKE MENU > Metadata Edit > Folder (Tape) |
| CIRCLED= | Circled take | MENU > FINDER > TAKE MENU > Metadata Edit > Circle |
| TR1= | Track 1 name | Track names are written as follows. TR1 = Tr1, TR2 = Tr2... TRL = TrL, TRR = TrR During dual channel recording, TR3 = Tr1, TR4 = Tr2. |
| TR2= | Track 2 name | |
| TR3= | Track 3 name | |
| TR4= | Track 4 name | |
| TR5= | Track 5 name | |
| TR6= | Track 6 name | |
| TRL= | Left track name | |
| TRR= | Right track name | |
| NOTE= | Take note | MENU > METADATA (NextTake) > Note > Edit MENU > FINDER > TAKE MENU > Metadata Edit > Note > Edit |

Metadata contained in iXML chunks in WAV files

| iXML master tag | iXML sub tag | Written | Read | Remarks |
|-----------------|--------------|---------|------|--|
| <PROJECT> | | ○ | ○ | MENU > FINDER (folder name at top SD card level) MENU > FINDER > TAKE MENU > Metadata Edit > Project |
| <SCENE> | | ○ | × | MENU > METADATA (Next Take) > Scene > Name Mode MENU > METADATA (Next Take) > User Scene Name MENU > FINDER > TAKE MENU > Rename |
| <TAKE> | | ○ | × | |
| <TAPE> | | ○ | ○ | MENU > FINDER (recording destination folder name) MENU > FINDER > TAKE MENU > Metadata Edit > Folder (Tape) |
| <CIRCLED> | | ○ | ○ | MENU > FINDER > TAKE MENU > Metadata Edit > Circle |
| <WILDTRACK> | | × | × | |
| <FALSE START> | | × | × | |
| <NO GOOD> | | × | × | |
| <FILE_UID> | | ○ | × | |
| <UBITS> | | ○ | × | MENU > TIMECODE (TC) > Ubits |
| <NOTE> | | ○ | ○ | MENU > REC > Next Take > Note MENU > FINDER > TAKE MENU > Metadata Edit > Note |
| <BEXT> | | × | × | |
| <USER> | | × | × | |

Metadata list (continued)

| iXML master tag | iXML sub tag | Written | Read | Remarks |
|-----------------|---------------------------------------|---------|------|---------------------------------|
| <SPEED> | | | | |
| <SPEED> | <NOTE> | o | x | |
| <SPEED> | <MASTER_SPEED> | o | o | MENU > TIMECODE (TC) > FPS |
| <SPEED> | <CURRENT_SPEED> | o | x | MENU > TIMECODE (TC) > FPS |
| <SPEED> | <TIMECODE_RATE> | o | x | MENU > TIMECODE (TC) > FPS |
| <SPEED> | <TIMECODE_FLAG> | o | x | MENU > TIMECODE (TC) > FPS |
| <SPEED> | <FILE_SAMPLE_RATE> | o | x | MENU > REC/PLAY > Sample Rate |
| <SPEED> | <AUDIO_BIT_DEPTH> | o | x | MENU > REC/PLAY > WAV Bit Depth |
| <SPEED> | <DIGITIZER_SAMPLE_RATE> | o | x | MENU > REC/PLAY > Sample Rate |
| <SPEED> | <TIMESTAMP_SAMPLES_SINCE_MIDNIGHT_HI> | o | x | |
| <SPEED> | <TIMESTAMP_SAMPLES_SINCE_MIDNIGHT_LO> | o | x | |
| <SPEED> | <TIMESTAMP_SAMPLE_RATE> | o | x | MENU > REC/PLAY > Sample Rate |

| iXML master tag | iXML sub tag | Written | Read | Remarks |
|-------------------|-----------------------------|---------|------|---------|
| <SYNC_POINT_LIST> | | | | |
| <SYNC_POINT> | <SYNC_POINT_TYPE> | x | x | |
| <SYNC_POINT> | <SYNC_POINT_FUNCTION> | x | x | |
| <SYNC_POINT> | <SYNC_POINT_COMMENT> | x | x | |
| <SYNC_POINT> | <SYNC_POINT_LOW> | x | x | |
| <SYNC_POINT> | <SYNC_POINT_HIGH> | x | x | |
| <SYNC_POINT> | <SYNC_POINT_EVENT_DURATION> | x | x | |

| iXML master tag | iXML sub tag | Written | Read | Remarks |
|-----------------|---------------------|---------|------|---------|
| <HISTORY> | | | | |
| <HISTORY> | <ORIGINAL_FILENAME> | o | x | |
| <HISTORY> | <PARENT_FILENAME> | x | x | |
| <HISTORY> | <PARENT_UID> | x | x | |

| iXML master tag | iXML sub tag | Written | Read | Remarks |
|-----------------|--------------------------|---------|------|---------|
| <FILE_SET> | | | | |
| <FILE_SET> | <TOTAL_FILES> | o | x | |
| <FILE_SET> | <FAMILY_UID> | o | x | |
| <FILE_SET> | <FAMILY_NAME> | x | x | |
| <FILE_SET> | <FILE_SET_START_TIME_HI> | x | x | |
| <FILE_SET> | <FILE_SET_START_TIME_LO> | x | x | |
| <FILE_SET> | <FILE_SET_INDEX> | o | x | |

| iXML master tag | iXML sub tag | Written | Read | Remarks |
|-----------------|--------------------|---------|------|---------|
| <TRACK_LIST> | | | | |
| <TRACK_LIST> | <TRACK_COUNT> | o | x | |
| <TRACK> | <CHANNEL_INDEX> | o | x | |
| <TRACK> | <INTERLEAVE_INDEX> | o | x | |
| <TRACK> | <NAME> | o | x | |
| <TRACK> | <FUNCTION> | x | x | |

















o = YES x = NO

Metadata and ID3 fields contained in MP3 files

| Metadata | ID3 field | Format |
|--------------------------------|-------------|--|
| Timecode | Artist Name | TC=[HH:MM:SS:FF] |
| Scene name, take number | Track Title | SC=[scene name] TK=[take number] |
| Frame rate, file length (time) | Album Title | FR=[frame rate] D=[file length (time)] |

List of shortcuts





Home Screen

| Shortcut | Explanation |
|---|--|
| Press and hold  | Show the name and track used for the next take recorded. Example: Scene1_002 |
|  +  | Advance the scene number by 1 (when the Home Screen is open). |
| Press and hold  | Move the previously recorded take to the FALSE TAKE folder (when the Home Screen is open). |
|  + 1 | Open MENU > TIMECODE (TC) > Jam screen. |
|  + 2 | Open the MENU > INPUT > Trim Link screen. |
|  + PFL  (Track 1) | Disable operations using  . |
|  + PFL  (Track 2) | Clear the level meter clipping indicators. |
|  + PFL  (Track 3) | Open the L/R track fader settings screen. |
|  + 1 | Open the MENU > METADATA (Next Take) > Scene > Scene Note screen. |
|  + 2 | Open the MENU > METADATA (Next Take) > Scene > User Scene Name screen. |
|  + 3 | Open the MENU > METADATA (Next Take) > Track Name screen. |
|  + 4 | Circle the currently selected take. |

Menu Screen

| Shortcut | Explanation |
|---|---|
| Press and hold  | Cancel the setting and return to the Home Screen. |

Character input screen

| Shortcut | Explanation |
|---|--|
| Press and turn  | Move the cursor vertically on a character input screen keyboard. |
|  +  | Delete a character on a character input screen. |
|  +  | Move the cursor to "Enter" on a character input screen keyboard. |

Routing screen

| Shortcut | Explanation |
|---|----------------------------|
| Press and turn  | Move the cursor vertically |

Specifications

| Recording media | | Dual SD card slots support 16MB–2GB SD cards, 4GB–32GB SDHC cards, 64GB–512GB SDXC cards | | |
|---------------------------|---|--|--|--|
| Inputs | INPUT 1–4 | Connector | XLR/TRS combo jacks (XLR: 2 hot, TRS: TIP hot) | |
| | XLR inputs (MIC) | Input gain | +10 to +75 dB | |
| | | Input impedance | 3 k Ω or more | |
| | | Maximum input level | +14 dBu (at 0 dBFS, limiter ON) | |
| | | Phantom power | +24/+48V 10mA maximum for each channel | |
| | TRS inputs (LINE) | Input gain | –10 to +55 dB | |
| | | Input impedance | 22 k Ω or more | |
| | | Maximum input level | +24 dBu (at 0 dBFS, limiter ON) | |
| | Equivalent input noise | –127 dBu or less (A-weighted, +75dB input gain, 150 Ω input) | | |
| | Frequency characteristics | 10 Hz – 80 kHz +0.5dB/–1.5dB (192kHz sampling rate) | | |
| | A/D dynamic range | 120 dB typ (–60dBFS input, A-weighted) | | |
| | Crosstalk | –90 dB or less (between adjacent channels, 1kHz) | | |
| | RTN (INPUT 5/6) | Connector | 3.5mm stereo mini | |
| Nominal input gain | | –10 dBV/+4 dBu | | |
| Input impedance | | 10 k Ω or more | | |
| Maximum input level | | +10 dBV (Level: –10 dBV), +24 dBu (Level: +4 dBu) | | |
| MIC IN (INPUT 5/6) | ZOOM mic capsule input (disables RTN (INPUT 5/6) when used) | | | |
| Outputs | MAIN OUT 1/2 | Connectors | XLR balanced output (2: hot) | |
| | | Output impedance | 150 Ω or less | |
| | | Reference output level | –10 dBV, 1 kHz, 600 Ω load | |
| | | Maximum output level | +10 dBV, 1 kHz, 600 Ω load | |
| | SUB OUT 1/2 | Connector | 3.5mm stereo mini unbalanced output jack | |
| | | Output impedance | 1 k Ω or less | |
| | | Reference output level | –10 dBV (Output Type: Normal), –40 dBV (Output Type: Mic), 1kHz, 10k Ω load | |
| | | Maximum output level | +10 dBV (Output Type: Normal), –20 dBV (Output Type: Mic), 1kHz, 10k Ω load | |
| | HEADPHONE | Connector | 1/4" stereo unbalanced output jack | |
| | | Output impedance | 15 Ω or less | |
| | | Maximum output level | 100mW + 100mW (32 Ω load) | |
| | D/A dynamic range | 106 dB typ (–60dBFS input, A-weighted) | | |

Specifications (continued)

| | | |
|----------------------------------|--|---|
| Recording formats | When WAV selected | |
| | Supported formats: | 44.1/47.952/48/48.048/88.2/96/192kHz, 16/24-bit, mono/stereo//2-8ch poly, BWF and iXML |
| | Maximum simultaneous recording tracks | 8 (6 Inputs + LR MIX recording at 192kHz sampling rate) |
| | When MP3 selected | |
| | Supported formats: | 128/192/320kbps, 44.1/48kHz, ID3v1 tags |
| | Maximum simultaneous recording tracks | 2 |
| Recording time | Using a 32GB card | |
| | 30:51:00 (48kHz/24-bit stereo WAV) | |
| | 7:42:00 (192kHz/24-bit stereo WAV) | |
| Timecode | Connector | BNC |
| | Modes | Off, Int Free Run, Int Record Run, Int RTC Run, Ext, Ext Auto Rec (audio clock can be synchronized to timecode) |
| | Frame rate | 23.976ND, 24ND, 25ND, 29.97ND, 29.97D, 30ND, 30D |
| | Precision | ±0.2 ppm |
| | Allowed input level | 0.2 – 5.0 Vpp |
| | Input impedance | 4.3 kΩ or more |
| | Output level | 3.0 Vpp ±10% |
| | Output impedance | 50 Ω or less |
| Power | Batteries: 8 AA | |
| | External DC power supply: HIROSE HR10A-7R-4S 4-pin connector (1 pin: -, 4 pin: +), 9–16 V | |
| Continuous recording time | 48kHz/16-bit 2ch recording to SD1 (MAIN/SUB OUT OFF, TIME CODE OFF, LED Brightness 5, 32Ω load headphones, PHANTOM OFF) | |
| | Alkaline batteries | 9.5 hours or more |
| | NiMH (2450mAh) | 11.5 hours or more |
| | Lithium batteries | 17.5 hours or more |
| | 48kHz/24-bit 4ch recording to SD1 (MAIN/SUB OUT OFF, TIME CODE OFF, LED Brightness 5, 32Ω load headphones, PHANTOM OFF) | |
| | Alkaline batteries | 9 hours or more |
| | NiMH (2450mAh) | 10.5 hours or more |
| | Lithium batteries | 16.5 hours or more |

| | | |
|----------------------------------|--|---|
| Continuous recording time | 192kHz/24-bit 4ch recording to SD1/SD2 (MAIN/SUB OUT ON, TIME CODE set to Int Free Run, LED Brightness 60, 32Ω load headphones, PHANTOM set to 48V) | |
| | Alkaline batteries | 2 hours or more |
| | NiMH (2450mAh) | 3.5 hours or more |
| | Lithium batteries | 6 hours or more |
| Display | 128x64 LCD with backlight | |
| USB | Mass storage operation | |
| | Class: | USB 2.0 High Speed |
| | MultiTrack audio interface operation (driver required for Windows, not required for Mac) | |
| | Class: | USB 2.0 High Speed |
| | Specifications: | 44.1/48/96kHz sampling rate, 16/24-bit bit rate, 6 in/4 out |
| | Stereo Mix audio interface operation (no driver required) | |
| | Class: | USB 2.0 Full Speed |
| Specifications: | 44.1/48kHz sampling rate, 16-bit bit rate, 2 in/2 out | |
| | Note: iOS device audio interface operation supported (stereo mode only) | |
| Power consumption | 12 W | |
| External dimensions | Main unit: 177.8 mm (W) × 141.1 mm (D) × 54.3 mm (H) | |
| Weight (main unit only) | 1030 g | |



ZOOM CORPORATION

4-4-3 Kandasurugadai, Chiyoda-ku, Tokyo 101-0062 Japan

<http://www.zoom.co.jp>